



User Manual

SP24 AXPERT KING II **5KW/6KW** **SOLAR INVERTER / CHARGER**



Table Of Contents

| | |
|--------------------------------------------------------------------|-----------|
| ABOUT THIS MANUAL | 2 |
| Purpose..... | 2 |
| Scope..... | 2 |
| SAFETY INSTRUCTIONS | 2 |
| INTRODUCTION | 3 |
| Features | 3 |
| Basic System Architecture | 3 |
| Product Overview..... | 4 |
| INSTALLATION | 5 |
| Unpacking and Inspection | 5 |
| Preparation | 5 |
| Mounting the Unit..... | 5 |
| Battery Connection | 6 |
| AC Input/Output Connection..... | 7 |
| PV Connection | 9 |
| Final Assembly..... | 10 |
| Remote Display Panel Installation..... | 10 |
| Communication Connection..... | 12 |
| Dry Contact Signal..... | 12 |
| BMS Communication | 12 |
| OPERATION | 13 |
| Power ON/OFF | 13 |
| Operation and Display Panel | 13 |
| LCD Display Icons | 14 |
| LCD Setting..... | 16 |
| Display Setting | 26 |
| Operating Mode Description | 30 |
| Fault Reference Code..... | 33 |
| Warning Indicator..... | 33 |
| Battery Equalization | 34 |
| SPECIFICATIONS | 36 |
| Table 1 Line Mode Specifications | 36 |
| Table 2 Battery Mode Specifications | 37 |
| Table 3 Charge Mode Specifications..... | 38 |
| Table 4 ECO/Bypass Mode Specifications..... | 39 |
| TROUBLE SHOOTING | 40 |
| PARALLEL FUNCTION | 41 |
| Appendix A: Approximate Back-up Time Table | 60 |
| Appendix B: BMS Communication Installation | 61 |
| Appendix C: The Wi-Fi Operation Guide in Remote Panel | 66 |

ABOUT THIS MANUAL

Purpose

This manual describes the assembly, installation, operation and troubleshooting of this unit. Please read this manual carefully before installations and operations. Keep this manual for future reference.

Scope

This manual provides safety and installation guidelines as well as information on tools and wiring.

SAFETY INSTRUCTIONS



WARNING: This chapter contains important safety and operating instructions. Read and keep this manual for future reference.

1. Before using the unit, read all instructions and cautionary markings on the unit, the batteries and all appropriate sections of this manual.
2. **CAUTION** --To reduce risk of injury, charge only deep-cycle lead acid type rechargeable batteries. Other types of batteries may burst, causing personal injury and damage.
3. Do not disassemble the unit. Take it to a qualified service center when service or repair is required. Incorrect re-assembly may result in a risk of electric shock or fire.
4. To reduce risk of electric shock, disconnect all wirings before attempting any maintenance or cleaning. Turning off the unit will not reduce this risk.
5. **CAUTION** – Only qualified personnel can install this device with battery.
6. **NEVER** charge a frozen battery.
7. For optimum operation of this inverter/charger, please follow required spec to select appropriate cable size. It's very important to correctly operate this inverter/charger.
8. Be very cautious when working with metal tools on or around batteries. A potential risk exists to drop a tool to spark or short circuit batteries or other electrical parts and could cause an explosion.
9. Please strictly follow installation procedure when you want to disconnect AC or DC terminals. Please refer to INSTALLATION section of this manual for the details.
10. Fuses are provided as over-current protection for the battery supply.
11. GROUNDING INSTRUCTIONS -This inverter/charger should be connected to a permanent grounded wiring system. Be sure to comply with local requirements and regulation to install this inverter.
12. NEVER cause AC output and DC input short circuited. Do NOT connect to the mains when DC input short circuits.
13. **Warning!!** Only qualified service persons are able to service this device. If errors still persist after following troubleshooting table, please send this inverter/charger back to local dealer or service center for maintenance.
14. **ATTENTION IN CASE OF MALFUNCTION OF THE PRODUCT PLEASE CONTACT US BY EMAIL AT assistenza@solarpower24.it WITH THE SERIAL NUMBER OF PRODUCT, EXACT MODEL, DEFECT FOUND AND YOU WILL BE CONTACTED. PLEASE NOTE THAT THE PRODUCT MUST NOT BE OPENED IN ANY WAY AND THAT OPENING WITH THE CONSEQUENT BREAKING OF THE WARRANTY SEAL VOIDS WARRANTY ON THE PRODUCT.**

INTRODUCTION

This is a multi-function inverter/charger, combining functions of inverter, MPPT solar charger and battery charger to offer uninterruptible power support with portable size. Its comprehensive LCD display offers user-configurable and easy-accessible button operation such as battery charging current, AC/solar charger priority, and acceptable input voltage based on different applications.

Features

- Pure sine wave inverter
- Built-in MPPT solar charge controller
- Configurable input voltage range for home appliances and personal computers via LCD setting
- Configurable battery charging current based on applications via LCD setting
- Configurable AC/Solar Charger priority via LCD setting
- Compatible to mains voltage or generator power
- Auto restart while AC is recovering
- Overload/ Over temperature/ short circuit protection
- Smart battery charger design for optimized battery performance
- Cold start function
- Zero-transfer Time

Basic System Architecture

The following illustration shows basic application for this inverter/charger. It also includes following devices to have a complete running system:

- Generator or Utility.
- PV modules

Consult with your system integrator for other possible system architectures depending on your requirements. This inverter can power all kinds of appliances in home or office environment, including motor-type appliances such as tube light, fan, refrigerator and air conditioner.

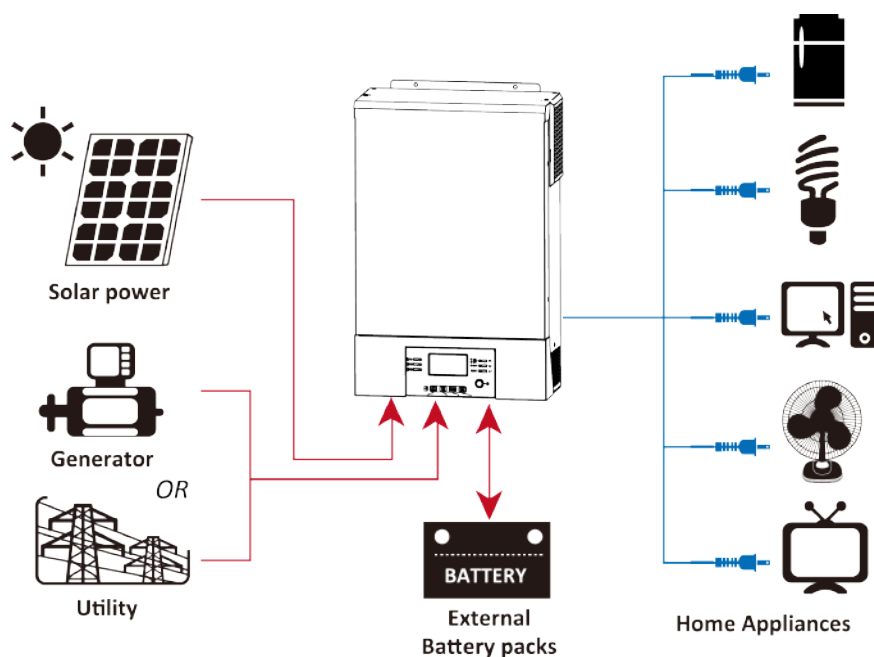
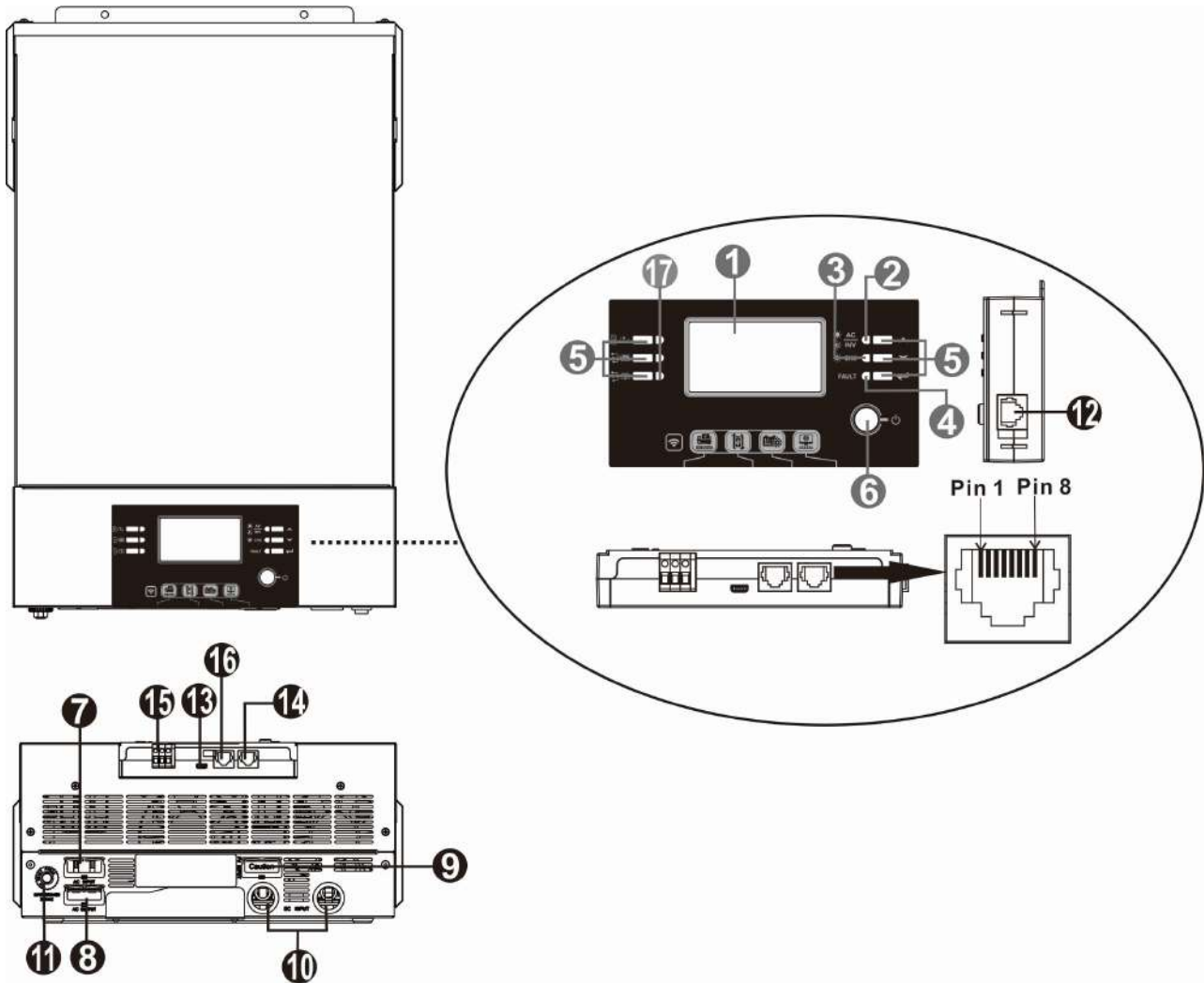

Figure 1 Hybrid Power System

Product Overview



1. LCD display
2. Status indicator
3. Charging indicator
4. Fault indicator
5. Function buttons
6. Power on/off switch
7. AC input
8. AC output
9. PV connectors
10. Battery input
11. Circuit breaker
12. Remote LCD panel communication port
13. USB port: for communication port and USB function port
14. RS-232 communication port
15. Dry contact
16. BMS communication port: CAN and RS232 or RS485
17. LED indicator for USB function settings

INSTALLATION

Unpacking and Inspection

Before installation, please inspect the unit. Be sure that nothing inside the package is damaged. You should have received the following items inside of package:

- The unit x 1
- User manual x 1
- Communication cable x 1
- Software CD x 1

Preparation

Before connecting all wirings, please take off bottom cover by removing two screws as shown below.

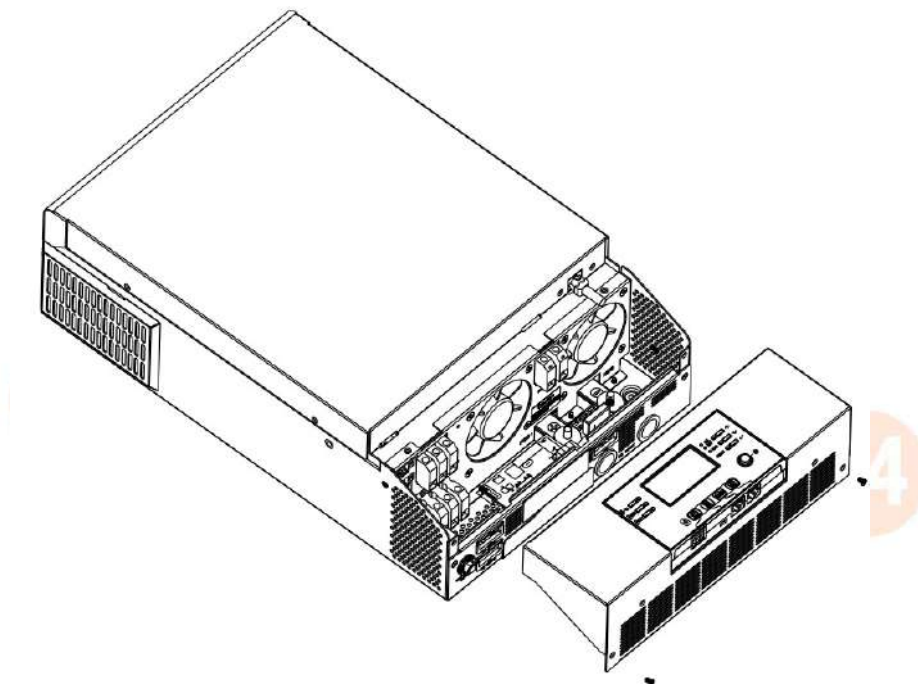

Mounting the Unit

Consider the following points before selecting where to install:

- Do not mount the inverter on flammable construction materials.
- Mount on a solid surface
- Install this inverter at eye level in order to allow the LCD display to be read at all times.
- The ambient temperature should be between 0°C and 55°C to ensure optimal operation.
- The recommended installation position is to be adhered to the wall vertically.
- Be sure to keep other objects and surfaces as shown in the right diagram to guarantee sufficient heat dissipation and to have enough space for removing wires.

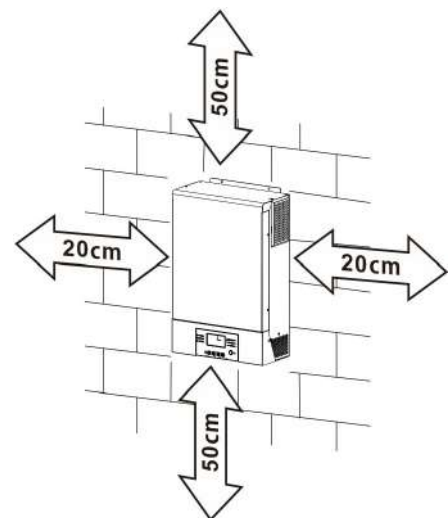

SUITABLE FOR MOUNTING ON CONCRETE OR OTHER NON-COMBUSTIBLE SURFACE ONLY.

Install the unit by screwing three screws. It's recommended to use M4 or M5 screws.

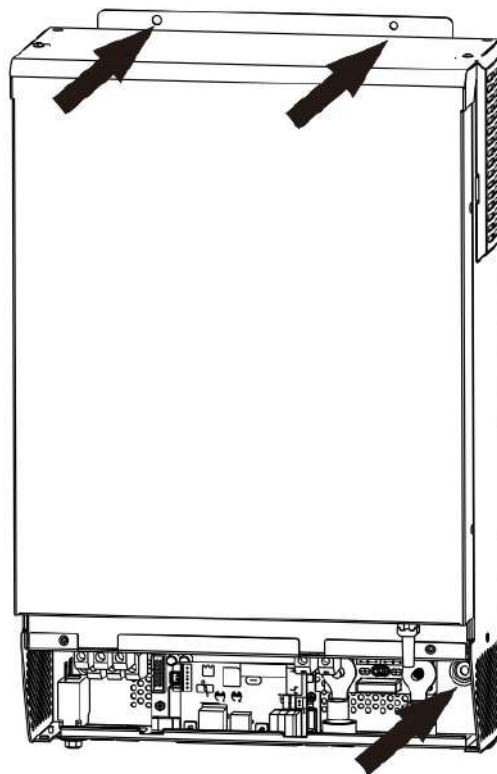

Battery Connection

CAUTION: For safety operation and regulation compliance, it's requested to install a separate DC over-current protector or disconnect device between battery and inverter. It may not be requested to have a disconnect device in some applications, however, it's still requested to have over-current protection installed. Please refer to typical amperage in below table as required fuse or breaker size.

WARNING! All wiring must be performed by a qualified personnel.

WARNING! It's very important for system safety and efficient operation to use appropriate cable for battery connection. To reduce risk of injury, please use the proper recommended cable and terminal size as below.

Ring terminal:

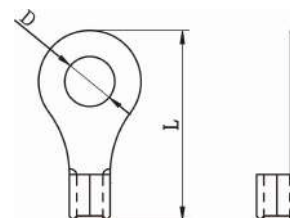



Recommended battery cable and terminal size:

| Model | Typical Amperage | Battery Capacity | Wire Size | Ring Terminal | | | Torque Value |
|---------|------------------|------------------|-----------|-----------------------|------------|--------|--------------|
| | | | | Cable mm ² | Dimensions | | |
| | | | | | D (mm) | L (mm) | |
| 5KW/6KW | 125A/150A | 200AH | 1*1/0AWG | 60 | 6.4 | 49.7 | 2~3 Nm |
| | | | 2*4AWG | 44 | 6.4 | 49.7 | |

Please follow below steps to implement battery connection:

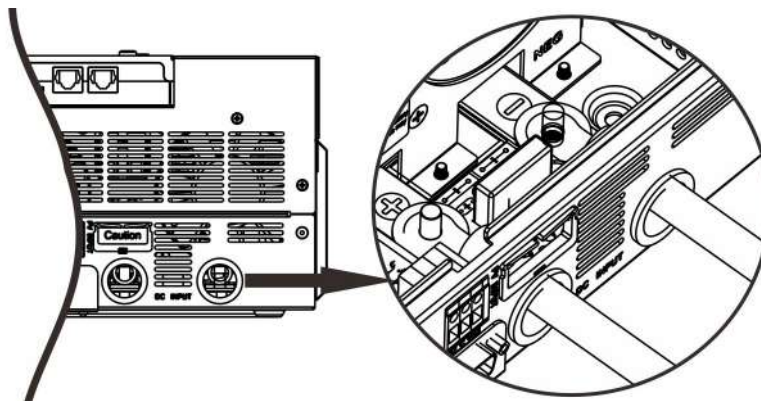
1. Assemble battery ring terminal based on recommended battery cable and terminal size.
2. Insert the ring terminal of battery cable flatly into battery connector of inverter and make sure the nuts are tightened with torque of 2-3 Nm. Make sure polarity at both the battery and the inverter/charge is correctly connected and ring terminals are tightly screwed to the battery terminals.



 **WARNING: Shock Hazard**
Installation must be performed with care due to high battery voltage in series.

 **CAUTION!!** Do not place anything between the flat part of the inverter terminal and the ring terminal. Otherwise, overheating may occur.
CAUTION!! Do not apply anti-oxidant substance on the terminals before terminals are connected tightly.
CAUTION!! Before making the final DC connection or closing DC breaker/disconnector, be sure positive (+) must be connected to positive (+) and negative (-) must be connected to negative (-).

AC Input/Output Connection

CAUTION!! Before connecting to AC input power source, please install a **separate** AC breaker between inverter and AC input power source. This will ensure the inverter can be securely disconnected during maintenance and fully protected from over current of AC input. The recommended spec of AC breaker is 50A.

CAUTION!! There are two terminal blocks with "IN" and "OUT" markings. Please do NOT mis-connect input and output connectors.

WARNING! All wiring must be performed by a qualified personnel.

WARNING! It's very important for system safety and efficient operation to use appropriate cable for AC input connection. To reduce risk of injury, please use the proper recommended cable size as below.

Suggested cable requirement for AC wires

| Model | Gauge | Torque Value |
|---------|-------|--------------|
| 5KW/6KW | 8 AWG | 1.4~ 1.6Nm |

Please follow below steps to implement AC input/output connection:

1. Before making AC input/output connection, be sure to open DC protector or disconnecter first.
2. Remove insulation sleeve 10mm for six conductors. And shorten phase L and neutral conductor N 3 mm.
3. Insert AC input wires according to polarities indicated on terminal block and tighten the terminal screws. Be sure to connect PE protective conductor (⊕) first.

 → **Ground (yellow-green)**

L → **LINE (brown or black)**

N → **Neutral (blue)**

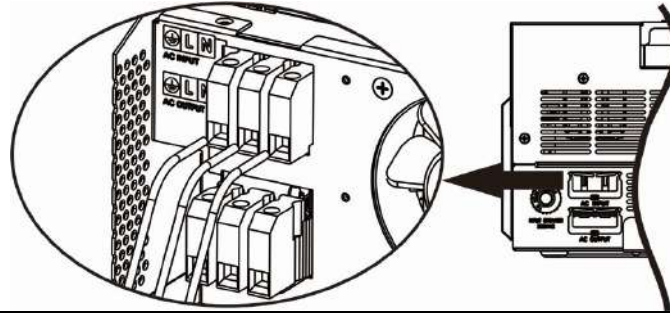

WARNING:

Be sure that AC power source is disconnected before attempting to hardwire it to the unit.

4. Then, insert AC output wires according to polarities indicated on terminal block and tighten terminal screws. Be sure to connect PE protective conductor (⊕) first.

⊕ → **Ground (yellow-green)**

L → **LINE (brown or black)**

N → **Neutral (blue)**

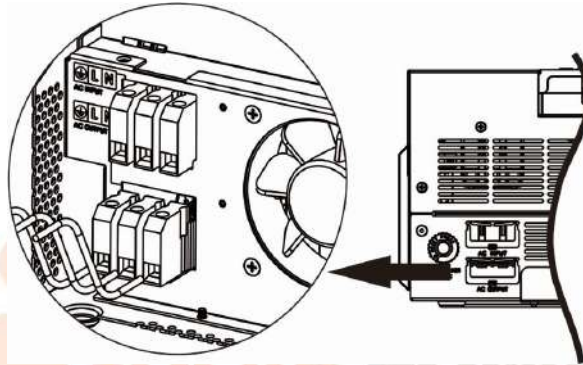

5. Make sure the wires are securely connected.

CAUTION: Important

Be sure to connect AC wires with correct polarity. If L and N wires are connected reversely, it may cause utility short-circuited when these inverters are worked in parallel operation.

CAUTION: Important

When input source is the generator, it's suggested to choose the generator by following parameters:

- The recommend generator rating should be at least 2X of inverter capacity.
- Generator output: Pure Sine Wave
- Generator output voltage rms range: 180 ~ 270Vac
- Generator output frequency range: 45Hz ~ 63Hz

It's recommended to test the generator with the inverter before the installation. Few generators complied above parameters may still not be accepted by the inverter as the input source.

CAUTION: Appliances such as air conditioner are required at least 2~3 minutes to restart because it's required to have enough time to balance refrigerant gas inside of circuits. If a power shortage occurs and recovers in a short time, it will cause damage to your connected appliances. To prevent this kind of damage, please check manufacturer of air conditioner if it's equipped with time-delay function before installation. Otherwise, this inverter/charger will trig overload fault and cut off output to protect your appliance but sometimes it still causes internal damage to the air conditioner.

PV Connection

CAUTION: Before connecting to PV modules, please install **separately** a DC circuit breaker between inverter and PV modules.

WARNING! All wiring must be performed by a qualified personnel.

WARNING! It's very important for system safety and efficient operation to use appropriate cable for PV module connection. To reduce risk of injury, please use the proper recommended cable size as below.

WARNING! Never connect the positive and negative terminals of the solar panel to the ground.

| Model | Typical Amperage | Cable Size | Torque |
|---------|------------------|------------|------------|
| 5KW/6KW | 27A | 10 AWG | 1.2~1.6 Nm |

PV Module Selection:

When selecting proper PV modules, please be sure to consider below parameters:

1. Open circuit Voltage (Voc) of PV modules not exceeds max. PV array open circuit voltage of inverter.
2. Open circuit Voltage (Voc) of PV modules should be higher than min. battery voltage.

| Solar Charging Mode | |
|-------------------------------------------|----------------|
| INVERTER MODEL | 5KW/6KW |
| Max. PV Array Open Circuit Voltage | 500Vdc |
| PV Array MPPT Voltage Range | 120~430Vdc |

Please follow below steps to implement PV module connection:

1. Remove insulation sleeve 10 mm for positive and negative conductors.
2. Check correct polarity of connection cable from PV modules and PV input connectors. Then, connect positive pole (+) of connection cable to positive pole (+) of PV input connector. Connect negative pole (-) of connection cable to negative pole (-) of PV input connector.

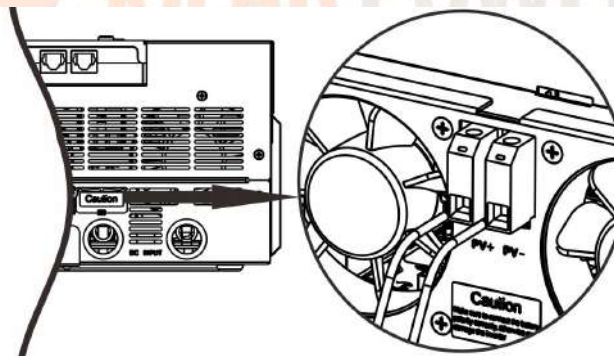
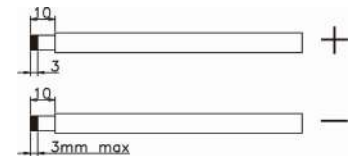

3. Make sure the wires are securely connected.

Final Assembly

After connecting all wirings, please put bottom cover back by screwing two screws as shown on the below chart.

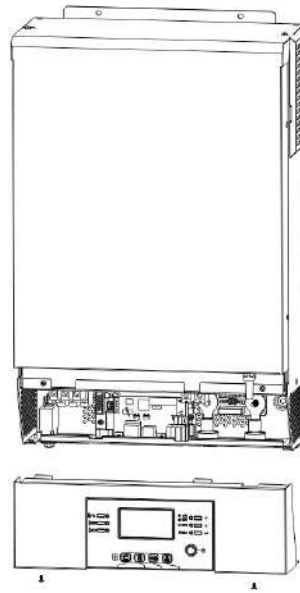

Remote Display Panel Installation

The LCD panel can be removable and installed in a remote site with an optional communication cable. Please follow below steps to implement this remote panel installation.

Step 1. Loosen the screw on the two sides of bottom case and push up the case cover. Then, remove screw on the top of the display panel. Now, the display can be removed from the bottom case. Then, pull out the cable from the remote communication port.

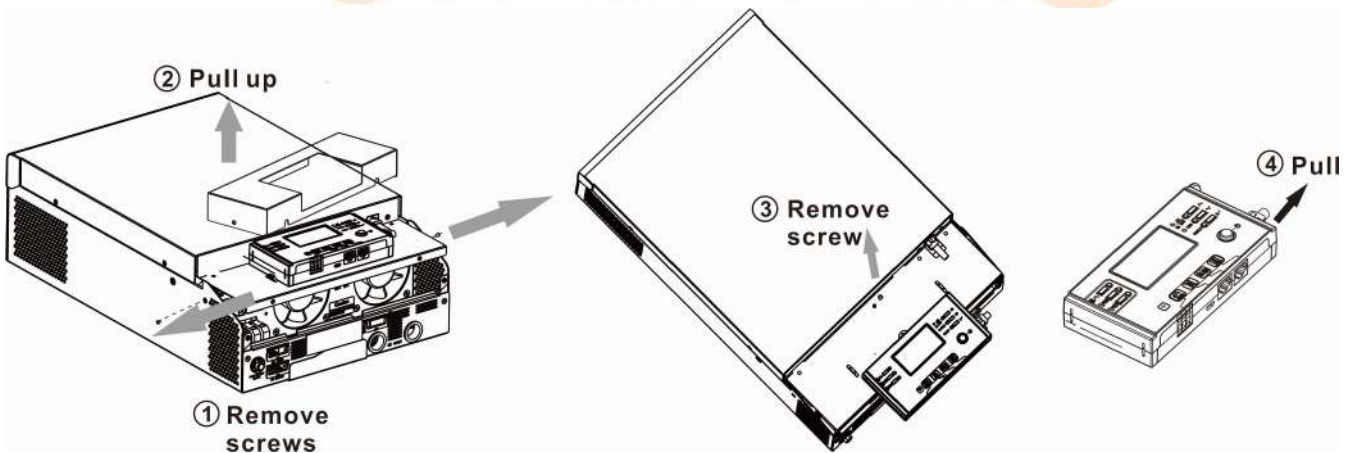

Step 2. Drill two holes in the marked locations with two screws as shown below chart. Place the panel on the surface and align the mounting holes with the two screws. Then, use one more screw on the top to fix the panel to the wall and check if the remote panel is firmly secured.

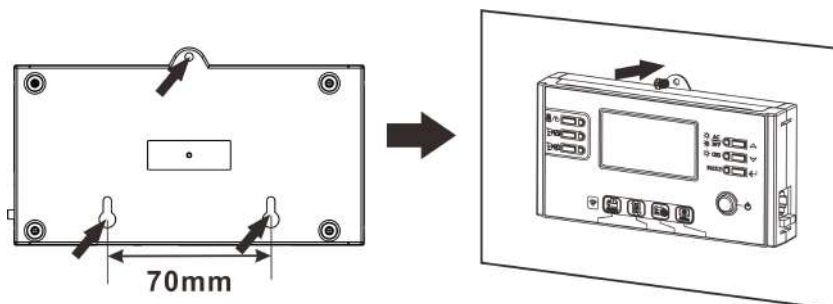

Note: Installation to the wall should be implemented with the proper screws. Refer chart for recommended spec of screws.



Step 3. Connect LCD panel to the inverter with an optional RJ45 communication cable as below chart.

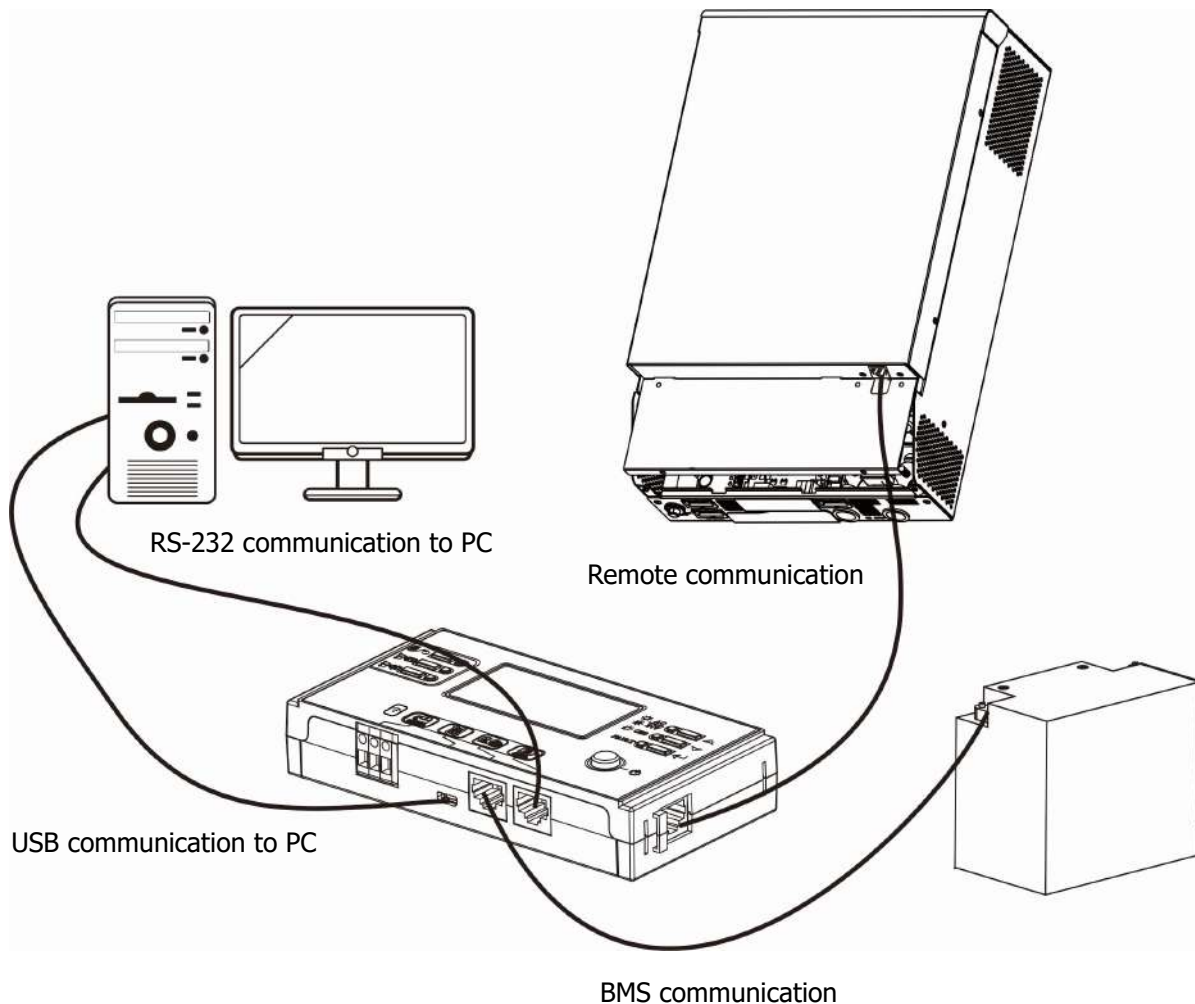

Communication Connection

Serial Connection

Please use supplied communication cable to connect to inverter and PC. Insert bundled CD into a computer and follow on-screen instruction to install the monitoring software. For the detailed software operation, please check user manual of software inside of CD.

Wi-Fi Connection

This unit is equipped with a Wi-Fi transmitter. Wi-Fi transmitter can enable wireless communication between off-grid inverters and monitoring platform. Users can access and control the monitored inverter with downloaded APP. You may find "WatchPower" app from the Apple® Store or "WatchPower Wi-Fi" in Google® Play Store. All data loggers and parameters are saved in iCloud. For quick installation and operation, please check Appendix C.



Dry Contact Signal

There is one dry contact (3A/250VAC) available on the rear panel. It could be used to deliver signal to external device when battery voltage reaches warning level.

| Unit Status | Condition | | Dry contact port:  | | |
|------------------------------------------------------------------------------------------|-------------------------------------------------------|--------------------------------------------------------------|--------------------------------------------------------------------------------------------------------|--------|-------|
| | | | NC & C | NO & C | |
| Power Off | Unit is off and no output is powered. | | Close | Open | |
| Power On | Output is powered from Utility. | | Close | Open | |
| | Output is powered from Battery power or Solar energy. | Program 01 set as USB (utility first) | Battery voltage < Low DC warning voltage | Open | Close |
| | | | Battery voltage > Setting value in Program 13 or battery charging reaches floating stage | Close | Open |
| | Output is powered from Battery power or Solar energy. | Program 01 is set as SBU (SBU priority) or SUB (solar first) | Battery voltage < Setting value in Program 12 | Open | Close |
| Battery voltage > Setting value in Program 13 or battery charging reaches floating stage | | | Close | Open | |

BMS Communication

If connecting to lithium battery, it's requested to buy a special communication cable. For the detailed BMS communication and installation, please check Appendix B – BMS Communication Installation.

OPERATION

Power ON/OFF

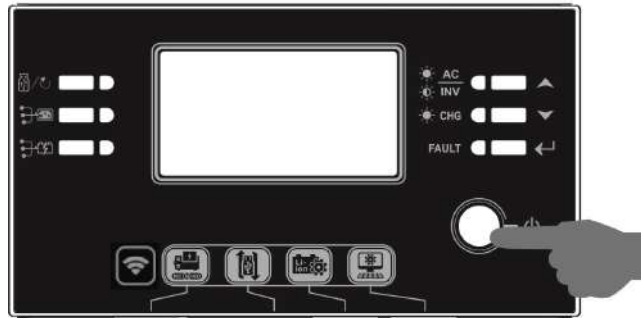



Once the unit has been properly installed and the batteries are connected well, simply press On/Off switch to turn on the unit.

Operation and Display Panel

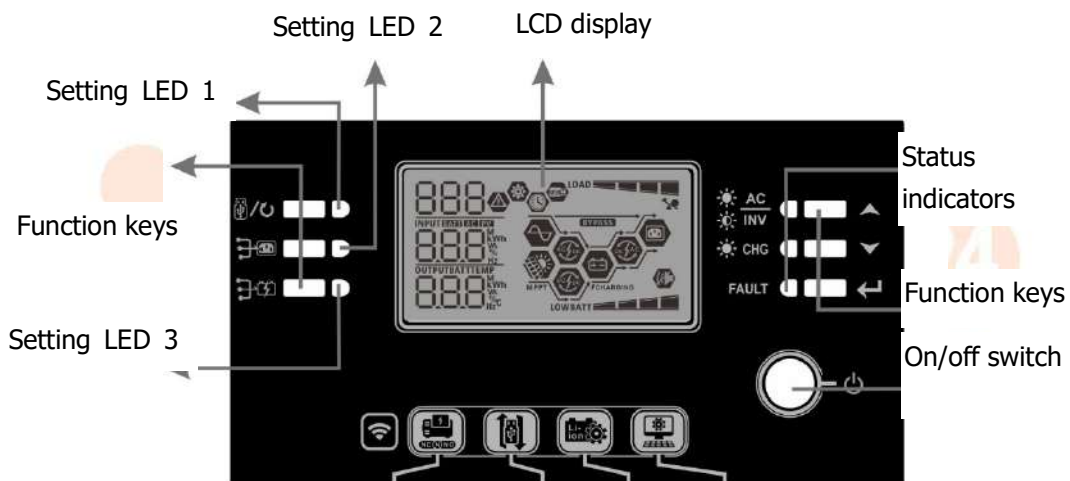



The operation and display panel, shown in below chart, is on the front panel of the inverter. It includes three indicators, four function keys and a LCD display, indicating the operating status and input/output power information.



LED Indicators







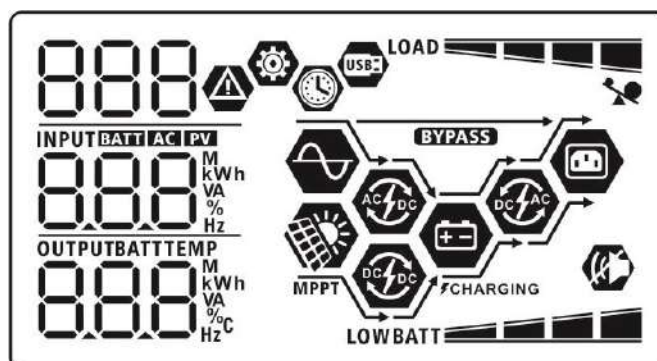

| LED Indicator | | | Messages |
|-------------------------|----------------------------------------------------------------------------------------------------------|----------|-----------------------------------------------------|
| Setting LED1 | Green | Solid On | Output powered by utility |
| Setting LED2 | Green | Solid On | Output powered by PV |
| Setting LED3 | Green | Solid On | Output powered by battery |
| Status Indicator |  AC INV | Solid On | Output is available in bypass mode |
| | | Flashing | Output is powered by battery or AC in inverter mode |
| |  CHG | Solid On | Battery is fully charged |
| | | Flashing | Battery is charging. |
| FAULT | Red | Solid On | Fault mode |
| | | Flashing | Warning mode |

Function Keys

| Function Key | | Description |
|-----------------------------------------------------------------------------------|----------------------|----------------------------------------------------------------|
|  | ESC | Exit setting mode |
| | USB function setting | Select USB OTG functions |
|  | Up | To last selection |
|  | Down | To next selection |
|  | Enter | To confirm the selection in setting mode or enter setting mode |

LCD Display Icons



| Icon | Function description | |
|-------------------------------------------------------------------------------------|-------------------------------------------------------------------------------------------------------------------------------------------------------------------------------------------------------------------------------------------------------------------------------------------|------------------------------------------------------------------------|
| Input Source Information | | |
|  | Indicates the AC input. | |
|  | Indicates the PV input | |
|  | Indicate input voltage, input frequency, PV voltage, charger current, charger power, battery voltage. | |
| Configuration Program and Fault Information | | |
|  | Indicates the setting programs. | |
|  | Indicates the warning and fault codes. Warning:  flashing with warning code. Fault:  lighting with fault code | |
| Output Information | | |
|  | Indicate output voltage, output frequency, load percent, load in VA, load in Watt and discharging current. | |
| Battery Information | | |
|  | Indicates battery level by 0-24%, 25-49%, 50-74% and 75-100% in battery mode and charging status in line mode. | |
| In AC mode, it will present battery charging status. | | |
| Status | Battery voltage | LCD Display |
| Constant Current mode / Constant Voltage mode | <2V/cell | 4 bars will flash in turns. |
| | 2 ~ 2.083V/cell | Bottom bar will be on and the other three bars will flash in turns. |
| | 2.083 ~ 2.167V/cell | Bottom two bars will be on and the other two bars will flash in turns. |
| | > 2.167 V/cell | Bottom three bars will be on and the top bar will flash. |









| | | | |
|----------------------------------------------------|----------------------------------------------------------------|--------------------|--|
| Floating mode. Batteries are fully charged. | | 4 bars will be on. | |
| In battery mode, it will present battery capacity. | | | |
| Load Percentage | Battery Voltage | LCD Display | |
| Load > 50% | < 1.85V/cell | LOWBATT | |
| | 1.85V/cell ~ 1.933V/cell | BATT | |
| | 1.933V/cell ~ 2.017V/cell | BATT | |
| | > 2.017V/cell | BATT | |
| Load < 50% | < 1.892V/cell | LOWBATT | |
| | 1.892V/cell ~ 1.975V/cell | BATT | |
| | 1.975V/cell ~ 2.058V/cell | BATT | |
| | > 2.058V/cell | BATT | |
| Load Information | | | |
| | Indicates overload. | | |
| | Indicates the load level by 0-24%, 25-49%, 50-74% and 75-100%. | | |
| | 0%~24% | 25%~49% | |
| | | | |
| | 50%~74% | 75%~100% | |
| | | | |
| Mode Operation Information | | | |
| | Indicates unit connects to the mains. | | |
| | Indicates unit connects to the PV panel. | | |
| BYPASS | Indicates load is supplied by utility power. | | |
| | Indicates the utility charger circuit is working. | | |
| | Indicates the solar charger circuit is working. | | |
| | Indicates the DC/AC inverter circuit is working. | | |
| | Indicates unit alarm is disabled. | | |
| | Indicates USB disk is connected. | | |
| | Indicates timer setting or time display | | |

LCD Setting







After pressing and holding "←" button for 3 seconds, the unit will enter setting mode. Press "▲" or "▼" button to select setting programs. And then, press "←" button to confirm the selection or "⏏/↺" button to exit.











Setting Programs:

| Program | Description | Selectable option | |
|---------|--------------------------------------------------------------------|-----------------------------------------------|--------------------------------------------------------------------------------------------------------------------------------------------------------------------------------------------------------------------------------------------------------------------------------------------------------------------------------------------------------------------------------------|
| 00 | Exit setting mode | Escape 00 ⚙️ ESC | |
| 01 | Output source priority: To configure load power source priority | USB : Utility first (default) 01 ⚙️ USB | Utility will provide power to the loads as first priority. If Utility energy is unavailable, solar energy and battery provides power the loads. |
| | | SUB: Solar first 01 ⚙️ SUB | Solar energy provides power to the loads as first priority. If solar energy is not sufficient to power all connected loads, utility energy will supply power to the loads at the same time. Battery provides power to the loads only when solar and utility is not sufficient. |
| | | SBU priority 01 ⚙️ SBU | Solar energy provides power to the loads as first priority. If solar energy is not sufficient to power all connected loads, battery energy will supply power to the loads at the same time. Utility provides power to the loads only when battery voltage drops to either low-level warning voltage or the setting point in program 12 or solar and battery is not sufficient. |







| | | | |
|--------------------------------------------------------------------------------------------------------------------------------------|---------------------------------------------------------------------------------------------------------------------------------------------------------------------------------|------------------------------------------------------------------------------------------------------------------------------|--------------------------------------------------------------------------------------------------------------------------------------------------------------------|
| 02 | Maximum charging current: To configure total charging current for solar and utility chargers. (Max. charging current = utility charging current + solar charging current) | 60A (default) 02  60 ^A | 5KW model setting range is from 10A to 100A and increment of each click is 10A. 6KW model setting range is from 10A to 120A and increment of each click is 10A. |
| 05 | Battery type | AGM (default) 05  AGM | Flooded 05  FLD |
| | | User-Defined 05  USE | If "User-Defined" is selected, battery charge voltage and low DC cut-off voltage can be set up in program 26, 27 and 29. |
| | | Pylontech battery 05  PYL | If selected, programs of 02, 26, 27 and 29 will be automatically set up. No need for further setting. |
| | | WECO battery 05  WEC | If selected, programs of 02, 12, 26, 27 and 29 will be auto-configured per battery supplier recommended. No need for further adjustment. |
| | | Soltaro battery 05  SOL | If selected, programs of 02, 26, 27 and 29 will be automatically set up. No need for further setting. |
| LIB-protocol compatible battery 05  LIB | Select " LIB" if using Lithium battery compatible to Lib protocol. If selected, programs of 02, 26, 27 and 29 will be automatically set up. No need for further setting. | | |

| | | | |
|----|---------------------------------------------------------------------------------------------------------------------------------------------------------------------------------------------------|----------------------------------------------------|----------------------------------------------------------------------------------------------------------------------------------------------------------------------------------------------------------------|
| 05 | Battery type | 3 rd party Lithium battery 05 LIC | If selected, programs of 02, 26, 27 and 29 will be automatically set up. No need for further setting. Please contact the battery supplier for installation procedure. |
| 06 | Auto restart when overload occurs | Restart disable (default) 06 Lfd | Restart enable 06 LFE |
| 07 | Auto restart when over temperature occurs | Restart disable (default) 07 tfd | Restart enable 07 tFE |
| 09 | Output frequency | 50Hz (default) 09 50 _{Hz} | 60Hz 09 60 _{Hz} |
| 10 | Operation Logic | Automatically (default) 10 AUT | If selected and utility is available, inverter will work in line mode. Once utility frequency is unstable, inverter will work in bypass mode if bypass function is not forbidden in program 23. |
| | | Online mode 10 ONL | If selected, inverter will work in line mode when utility is available. |
| | | ECO Mode 10 ECO | If selected and bypass is not forbidden in program 23, inverter will work in ECO mode when utility is available. |
| 11 | Maximum utility charging current Note: If setting value in program 02 is smaller than that in program in 11, the inverter will apply charging current from program 02 for utility charger. | 30A (default for 5KW) 11 30 ^A | For 5KW model, default setting is 30A and setting range is 1A, then from 10A to 100A. For 6KW model, default setting is 60A and setting range is 1A, then from 10A to 120A. Increment of each click is 10A. |

| | | | |
|----|------------------------------------------------------------------------------------------------|---------------------------------------------------------------------------------------------------------------------------------------------------------------------------------------------|--------------------------------------------------------------------------------------------------------|
| 12 | Setting voltage point back to utility source when selecting "SBU" (SBU priority) in program 01 | Default setting: 46.0V  | Setting range is from 44.0V to 57.0V and increment of each click is 1.0V. |
| 13 | Setting voltage point back to battery mode when selecting "SBU" (SBU priority) in program 01 | The setting range is from 48.0V to 64.0V and increment of each click is 1.0V. Battery fully charged  | 54.0V (default)  |
| 16 | Solar energy priority: To configure solar energy priority for battery and load | Sbl: Solar energy for battery first UCB: Allow utility to charge battery (Default)  | Solar energy charges battery first and allow the utility to charge battery. |
| | | Sbl: Solar energy for battery first UdC: Disallow utility to charge battery  | Solar energy charge battery first and disallow the utility to charge battery. |
| | | SLb: Solar energy for load first UCb: Allow utility to charge battery  | Solar energy provides power to the load first and also allow the utility to charge battery. |
| | | SLb: Solar energy for load first UdC: Disallow utility to charge battery  | Solar energy provides power to the load first and disallow the utility to charge battery. |

| | | | |
|----|-------------------------------------------|-------------------------------------------------------------------------------------------------------------------------------------------|-----------------------------------------------------------------------------------------------------------------------------------------------------------------------------------------|
| 18 | Alarm control | Alarm on (default) 18  b0n | Alarm off 18  b0f |
| 19 | Auto return to default display screen | Return to default display screen (default) 19  ESP | If selected, no matter how users switch display screen, it will automatically return to default display screen (Input voltage /output voltage) after no button is pressed for 1 minute. |
| | | Stay at latest screen 19  tEP | If selected, the display screen will stay at latest screen user finally switches. |
| 20 | Backlight control | Backlight on (default) 20  L0n | Backlight off 20  L0f |
| 22 | Beeps while primary source is interrupted | Alarm on (default) 22  A0n | Alarm off 22  A0f |
| 23 | Bypass function: | Bypass Forbidden 23  b4f | If selected, inverter won't work in bypass/ECO modes. |
| | | Bypass disable 23  b4d | If selected and power ON button is pressed on, inverter can work in bypass/ECO mode only if utility is available. |
| | | Bypass enable (default) 23  b4E | If selected and no matter power ON button is pressed on or not, inverter can work in bypass mode if utility is available. |

| | | | |
|-----------------------|-------------------------------------------------------------------------------------------------------------------------------------------------------|------------------------------------------------------|-------------------------------------------------------------------------------------------------------------------------------------------------------------------------------------------------------------------------------------------------------------------------------------------------------------------------------------------------------------------------------------------------------------------------------------------------------------------------------------------------------------------------------------------------------------------|
| 25 | Record Fault code | Record enable 25 FEN | Record disable (default) 25 Fds |
| 26 | Bulk charging voltage (C.V voltage) | default setting: 56.4V 26 CU BATT 56.4V | If self-defined is selected in program 5, this program can be set up. Setting range is from 48.0V to 64.0V. Increment of each click is 0.1V. |
| 27 | Floating charging voltage | Default setting: 54.0V 27 FLU BATT 54.0V | If self-defined is selected in program 5, this program can be set up. Setting range is from 48.0V to 64.0V. Increment of each click is 0.1V. |
| 28 | AC output mode *This setting is able to set up only when the inverter is in standby mode, Be sure that on/off Switch is in "OFF" status. | Single 28 SIG | When the unit is operated alone, please select "SIG" in program 28. |
| | | Parallel 28 PAL | When the units are used in parallel for single phase application, please select "PAL" in program 28. Please refer to 5-1 for detailed information. |
| | | L1 phase 28 3P1 | When the units are operated in 3-phase application, please choose "3PX" to define each inverter. It is required to have at least 3 inverters or maximum 9 inverters to support three-phase equipment. It's required to have at least one inverter in each phase or it's up to four inverters in one phase. Please refers to 5-2 for detailed information. Please select "3P1" in program 28 for the inverters connected to L1 phase, "3P2" in program 28 for the inverters connected to L2 phase and "3P3" in program 28 for the inverters connected to L3 phase. |
| | | L2 phase 28 3P2 | |
| L3 phase 28 3P3 | Be sure to connect share current cable to units which are on the same phase. Do NOT connect share current cable between units on different phases. | | |

| | | | |
|----|--------------------------------------------------------------------------------------------------------------------------------------------------------------------------------------------------------------------------------------------------------------------------------------------------------------------------------------------------------------------------------------------------------------------|------------------------------------------------------------------------------------------------------------------------|-----------------------------------------------------------------------------------------------------------------------------------------------------------------------------------------------------------------------------------------------------------------------------------------------|
| 29 | <p>Low DC cut-off voltage:</p> <ul style="list-style-type: none"> ● If battery power is only power source available, inverter will shut down. ● If PV energy and battery power are available, inverter will charge battery without AC output. ● If PV energy, battery power and utility are all available, inverter will transfer to line mode and provide output power to loads. | <p>Default setting: 42.0V</p>  | <p>If self-defined is selected in program 5, this program can be set up. Setting range is from 40.0V to 54.0V. Increment of each click is 0.1V. Low DC cut-off voltage will be fixed to setting value no matter what percentage of load is connected.</p> |
| 32 | Bulk charging time | <p>auto-charging time (default)</p>  | <p>5min</p>  <p>If "User-Defined" is selected in program 05, this program can be set up. Setting range is from 5min to 900min. Increment of each click is 5min. Otherwise, Keeping auto-charging time.</p> |
| 33 | Battery equalization | <p>Battery equalization enable</p>  | <p>Battery equalization disable (default)</p>  <p>If "Flooded" or "User-Defined" is selected in program 05, this program can be set up.</p> |
| 34 | Battery equalization voltage | <p>Default setting: 58.4V</p>  | <p>Setting range is from 48.0V to 64.0V. Increment of each click is 0.1V.</p> |
| 35 | Battery equalized time | <p>60min (default)</p>  | <p>Setting range is from 5min to 900min. Increment of each click is 5min.</p> |

| | | | |
|----|------------------------------------------------------------------------------------------------------------------------|----------------------------------------------------------------------------------------------------------------------------------------------------------------------------------------------------------------------------------------------------------------------------------------------------------------------------------------------------------------------------------------------------------------|--------------------------------------------------------------------------|
| 36 | Battery equalized timeout | 120min (default) 36 ⚙️ 120 | Setting range is from 5min to 900 min. Increment of each click is 5 min. |
| 37 | Equalization interval | 30days (default) 37 ⚙️ 30d | Setting range is from 0 to 90 days. Increment of each click is 1 day |
| 39 | Equalization activated immediately | Disable (default) 39 ⚙️ AdS | Enable 39 ⚙️ AEN |
| | | If equalization function is enabled in program 33, this program can be set up. If "Enable" is selected in this program, it's to activate battery equalization immediately and LCD main page will shows "E9". If "Disable" is selected, it will cancel equalization function until next activated equalization time arrives based on program 37 setting. At this time, "E9" will not be shown in LCD main page. | |
| 40 | Reset all stored data for PV generated power and output load energy | Not reset(Default) 40 ⚙️ Nrt | Reset 40 ⚙️ rst |
| 93 | Erase all data log | Not reset(Default) 93 ⚙️ Nrt | Reset 93 ⚙️ rst |
| 94 | Data log recorded interval *The maximum data log number is 1440. If it's over 1440, it will re-write the first log. | 3 minutes 94 ⚙️ 3 | 5 minutes 94 ⚙️ 5 |
| | | 10 minutes(default) 94 ⚙️ 10 | 20 minutes 94 ⚙️ 20 |













| | | | |
|----|-----------------------|------------------|-------------------------------------------------|
| | | 30 minutes 94 | 60 minutes 94 |
| | | 30 | 60 |
| 95 | Time setting – Minute | 95 MIN 00 | For minute setting, the range is from 00 to 59. |
| 96 | Time setting – Hour | 96 HOU 00 | For hour setting, the range is from 00 to 23. |
| 97 | Time setting– Day | 97 DAY 01 | For day setting, the range is from 00 to 31. |
| 98 | Time setting– Month | 98 MON 01 | For month setting, the range is from 01 to 12. |
| 99 | Time setting – Year | 99 YEA 17 | For year setting, the range is from 17 to 99. |

USB Function Setting

Please insert USB disk into USB port (). Press and hold "/U" button for 3 seconds to enter USB function setting mode. These functions include to upgrade inverter firmware, export data log and re-write internal parameters from USB disk.

| Procedure | LCD Screen |
|---------------------------------------------------------------------------------------------|------------|
| Step 1: Press and hold "/U" button for 3 seconds to enter USB function setting mode. | UPC |
| Step 2: Press "/U", "" or "" button to enter the selectable setting programs. | SET LOG |

Step 3: Please select setting program by following the procedure.

| Program# | Operation Procedure | LCD Screen |
|---------------------------------------------------------------------------------------------------------------------|--------------------------------------------------------------------------------------------------------------------------------------------------------------------------------------------------------------------------------------------------------------------------------------------------------------------------------------------------------------------------------------------------------------------------------------------------------------------------------------------------------------------------------------------------------------------------------------------------------|------------------------------------------------------------------------------------------------------------------------------------------------------------------------------------------|
|  : Upgrade firmware | This function is to upgrade inverter firmware. If firmware upgrade is needed, please check with your dealer or installer for detail instructions. | |
|  : Re-write internal parameters | This function is to over-write all parameter settings (TEXT file) with settings in the On-The-Go USB disk from a previous setup or to duplicate inverter settings. Please check with your dealer or installer for detail instructions. | |
|  : Export data log | Press "  " button to export data log from the inverter to USB disk. If the selected function is ready, LCD will display "LOG". Press "  " button to confirm the selection again. | LOG   LOG |
| | <ul style="list-style-type: none"> ● Press "" button to select "Yes", LED 1 will flash once every second during the process. It will only display LOG and all LEDs will be on after this action is complete. Then, press "" button to return to main screen. ● Or press "" button to select "No" to return to main screen. | LOG   YES NO |

If no button is pressed for 1 minute, it will automatically return to main screen.

Error message for USB On-the-Go functions:

| Error Code | Messages |
|------------|-------------------------------------------------|
| U01 | No USB disk is detected. |
| U02 | USB disk is protected from copy. |
| U03 | Document inside the USB disk with wrong format. |

If any error occurs, error code will only show 5 seconds. After 5 seconds, it will automatically return to display screen.

Display Setting

The LCD display information will be switched in turn by pressing the "UP" or "DOWN" button. The selective information will be switched as per the following orders:

| Selectable information | LCD display |
|----------------------------------------------------------|------------------------------------------------|
| Input voltage/Output voltage (Default Display Screen) | <p>Input Voltage=230V, output voltage=230V</p> |
| Input frequency | <p>Input frequency=50Hz</p> |
| PV voltage | <p>PV voltage=300V</p> |
| PV current | <p>PV current = 2.5A</p> |
| PV power | <p>PV power = 500W</p> |

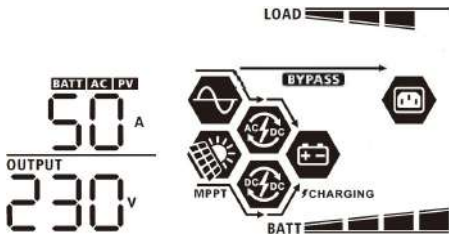
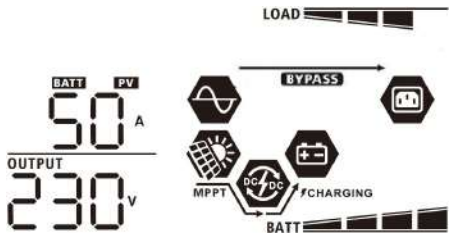
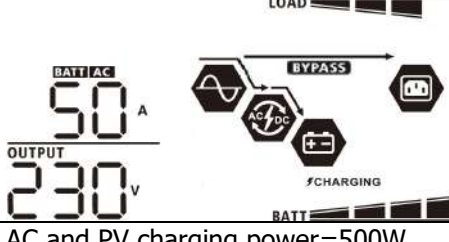
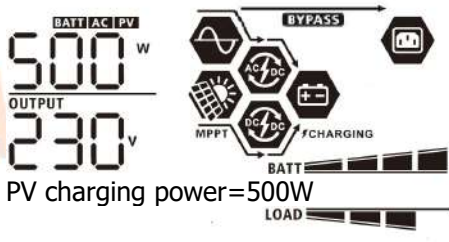
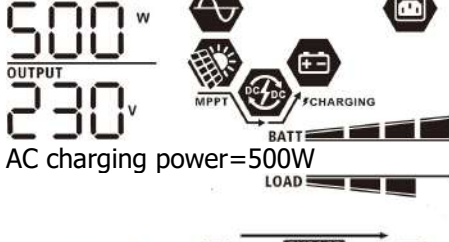
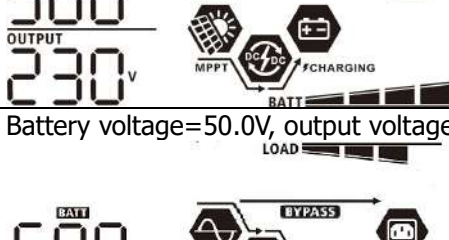
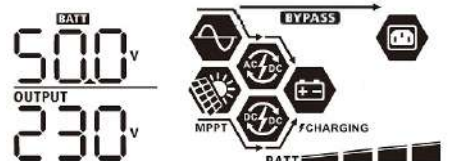

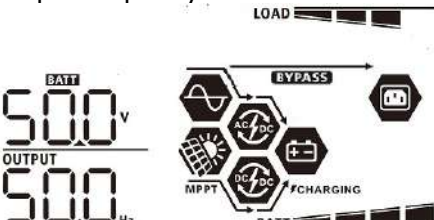
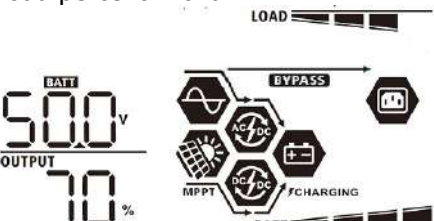
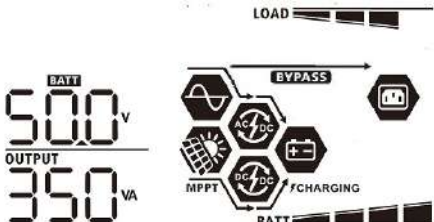
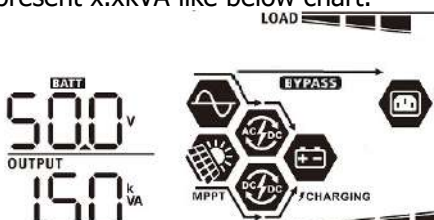
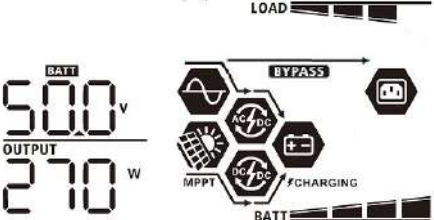
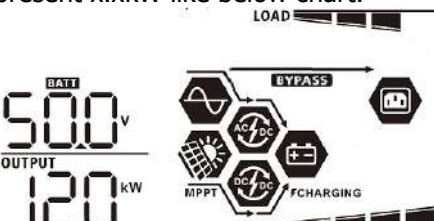
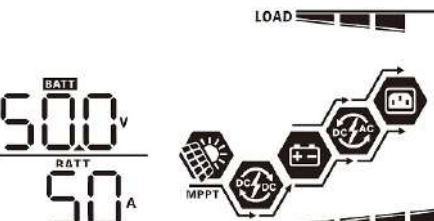

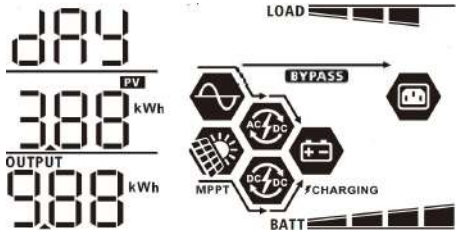
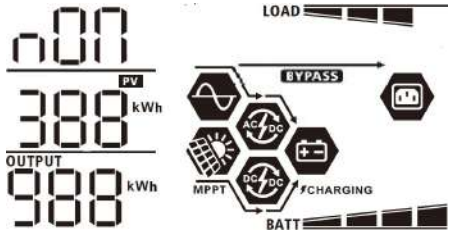
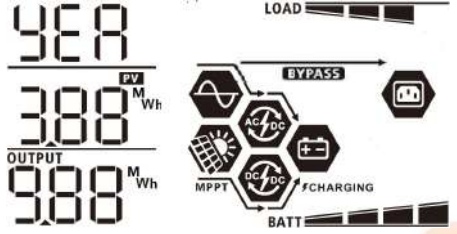
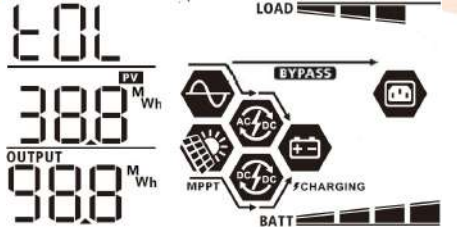
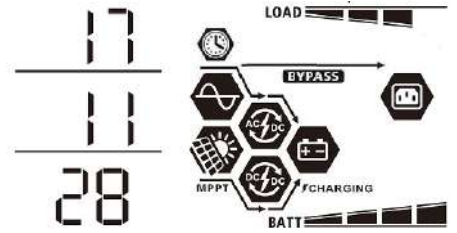
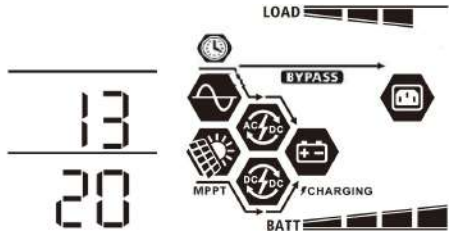
| | |
|------------------------------------|-----------------------------------------------------------------------------------------------------------------------------------------------------------------------------------------------------------------------------------------------------------------------------------------------------------------------------------------------------------------|
| Charging current | <p>AC and PV charging current=50A</p>  <p>PV charging current=50A</p>  <p>AC charging current=50A</p>  |
| Charging power | <p>AC and PV charging power=500W</p>  <p>PV charging power=500W</p>  <p>AC charging power=500W</p>  |
| Battery voltage and output voltage | <p>Battery voltage=50.0V, output voltage=230V</p>  |

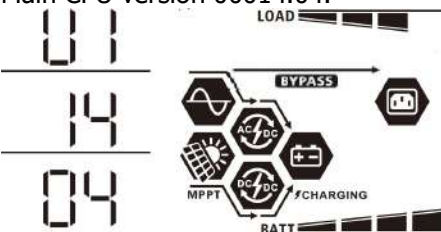
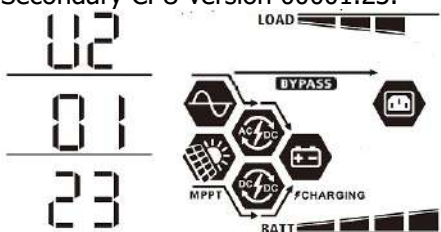
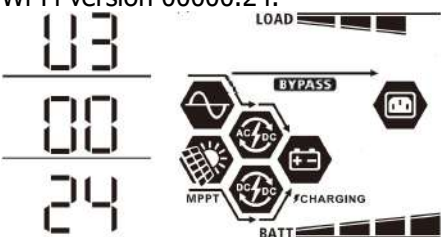

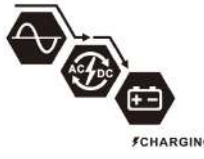

| | |
|----------------------------------------|---------------------------------------------------------------------------------------------------------------------------------------------------------------------------------------------------------------------------------------------------------------------------------------------------------------------------------------------------------------------------------------|
| Output frequency | <p>Output frequency=50Hz</p>  |
| Load percentage | <p>Load percent=70%</p>  |
| Load in VA | <p>When connected load is lower than 1kVA, load in VA will present xxxVA like below chart.</p>  <p>When load is larger than 1kVA ($\geq 1kVA$), load in VA will present x.xkVA like below chart.</p>  |
| Load in Watt | <p>When load is lower than 1kW, load in W will present xxxW like below chart.</p>  <p>When load is larger than 1kW ($\geq 1kW$), load in W will present x.xkW like below chart.</p>  |
| Battery voltage/DC discharging current | <p>Battery voltage=50.0V, discharging current=50A</p>  |

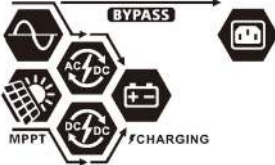
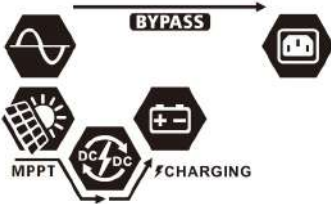
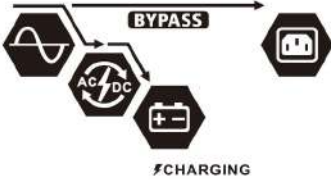

| | |
|--------------------------------------------------------------------------|--------------------------------------------------------------------------------------------------------------------------------------------------------------------|
| <p>PV energy generated today and Load output energy today</p> | <p>PV energy generated Today = 3.88kWh, Load output energy Today = 9.88kWh.</p>  |
| <p>PV energy generated this month and Load output energy this month.</p> | <p>This PV month energy = 388kWh, Load month energy = 988kWh.</p>  |
| <p>PV energy generated this year and Load output energy this year.</p> | <p>This PV year energy = 3.88MWh, Load year energy = 9.88MWh.</p>  |
| <p>PV energy generated totally and Load output total energy.</p> | <p>PV Total energy = 38.8MWh, Load Output Total energy = 98.8MWh.</p>  |
| <p>Real date.</p> | <p>Real date Nov 28, 2017.</p>  |
| <p>Real time.</p> | <p>Real time 13:20.</p>  |

| | |
|---------------------------------|---------------------------------------------------------------------------------------------------------------------------|
| Main CPU version checking. | <p>Main CPU version 00014.04.</p>  |
| Secondary CPU version checking. | <p>Secondary CPU version 00001.23.</p>  |
| Wi-Fi version checking. | <p>Wi-Fi version 00000.24.</p>  |

Operating Mode Description

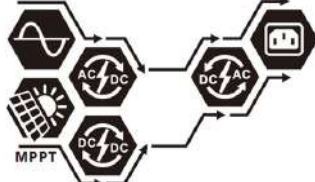
| Operation mode | Description | LCD display |
|----------------------------------------------------------------------------------------------------------------------------------------------------------------------|-----------------------------------------------------------------------------|----------------------------------------------------------------------------------------------------------------------------------------------------------------------------------------------------------------------------------------------------------------------------------------------------------------------------------------------------------------------------------------------------------------------------------------------------------------------------|
| <p>Standby mode</p> <p>Note:</p> <p>*Standby mode: The inverter is not turned on yet but at this time, the inverter can charge battery without AC output.</p> | <p>No output is supplied by the unit but it still can charge batteries.</p> | <p>Charging by utility and PV energy.</p>  <p>Charging by utility.</p>  <p>Charging by PV energy.</p>  <p>No charging.</p>  |
| <p>Fault mode</p> <p>Note:</p> <p>*Fault mode: Errors are caused by inside circuit error or external reasons such as</p> | <p>Utility can bypass.</p> | <p>No charging and Bypass</p>  <p>No charging</p> |

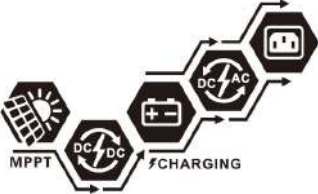
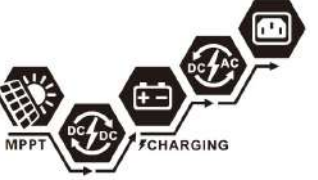
| | | |
|------------------------------------------------------------|---------------------------------------------------------------------------------------------------------|------------------------------------------------------------------------------------------------------------------------------------------------------------------------------------------------------------------------------------------------------------------------------------------------------------------------------------------------------------------------------|
| <p>over temperature, output short circuited and so on.</p> | |  |
| <p>Bypass/ECO Mode</p> | <p>The unit will provide output power from the utility. PV energy and utility can charge batteries.</p> | <p>Charging by utility and PV energy.</p>  <p>Charging by PV</p>  |
| <p>Bypass/ECO Mode</p> | <p>The unit will provide output power from the utility. PV energy and utility can charge batteries.</p> | <p>Charging by utility</p>  <p>No charging</p>  |
| <p>Line Mode</p> | <p>The unit will provide output power from the mains. It will also charge the battery at line mode.</p> | <p>Charging by utility and PV energy.</p>  <p>Charging by utility.</p>  <p>Power from utility and PV energy</p>  |

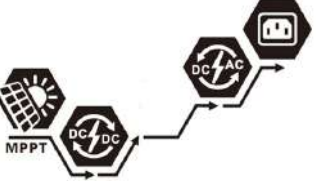







| | | |
|--------------|--------------------------------------------------------------------------------------------------|--------------------------------------------------------------------------------------------------------------------------------------------------------------------------|
| Line Mode | The unit will provide output power from the mains. It will also charge the battery at line mode. | <p>Power from utility only</p>  |
| Battery Mode | The unit will provide output power from battery and PV power. | <p>Power from battery and PV energy.</p>  |
| | | <p>PV energy will supply power to the loads and charge battery at the same time.</p>  |
| | | <p>Power from battery only.</p>  |
| | | <p>Power from PV only</p>  |



Fault Reference Code

| Fault Code | Fault Event | Icon on |
|------------|------------------------------------------------------------------------------------------|---------|
| 01 | Fan is locked when inverter is off. | F01 |
| 02 | Over temperature | F02 |
| 03 | Battery voltage is too high | F03 |
| 04 | Battery voltage is too low | F04 |
| 05 | Output short circuited or over temperature is detected by internal converter components. | F05 |
| 06 | Output voltage is too high. | F06 |
| 07 | Overload time out | F07 |
| 08 | Bus voltage is too high | F08 |
| 09 | Bus soft start failed | F09 |
| 50 | PFC over current | F50 |
| 51 | OP over current | F51 |
| 52 | Bus voltage is too low | F52 |
| 53 | Inverter soft start failed | F53 |
| 55 | Over DC voltage in AC output | F55 |
| 57 | Current sensor failed | F57 |
| 58 | Output voltage is too low | F58 |

Warning Indicator

| Warning Code | Warning Event | Audible Alarm | Icon flashing |
|--------------|------------------------------------|-------------------------------|--------------------------------------------------------------------------------------------------------------------------------------------------------------------------------|
| 01 | Fan is locked when inverter is on. | Beep three times every second | 01  |
| 02 | Over temperature | None | 02  |
| 03 | Battery is over-charged | Beep once every second | 03  |
| 04 | Low battery | Beep once every second | 04  |
| 07 | Overload | Beep once every 0.5 second | 07   |
| 10 | Output power derating | Beep twice every 3 seconds | 10  |
| 32 | Communication interrupted | None | 32  |
| E9 | Battery equalization | None | E9  |
| bP | Battery open | Beep once every second | bP |

Battery Equalization

Equalization function is added into charge controller. It reverses the buildup of negative chemical effects like stratification, a condition where acid concentration is greater at the bottom of the battery than at the top. Equalization also helps to remove sulfate crystals that might have built up on the plates. If left unchecked, this condition, called sulfation, will reduce the overall capacity of the battery. Therefore, it's recommended to equalize battery periodically.

- **How to Apply Equalization Function**

You must enable battery equalization function in monitoring LCD setting program 33 first. Then, you may apply this function in device by either one of following methods:

1. Setting equalization interval in program 37.
2. Active equalization immediately in program 39.

- **When to Equalize**

In float stage, when the setting equalization interval (battery equalization cycle) is arrived, or equalization is active immediately, the controller will start to enter Equalize stage.

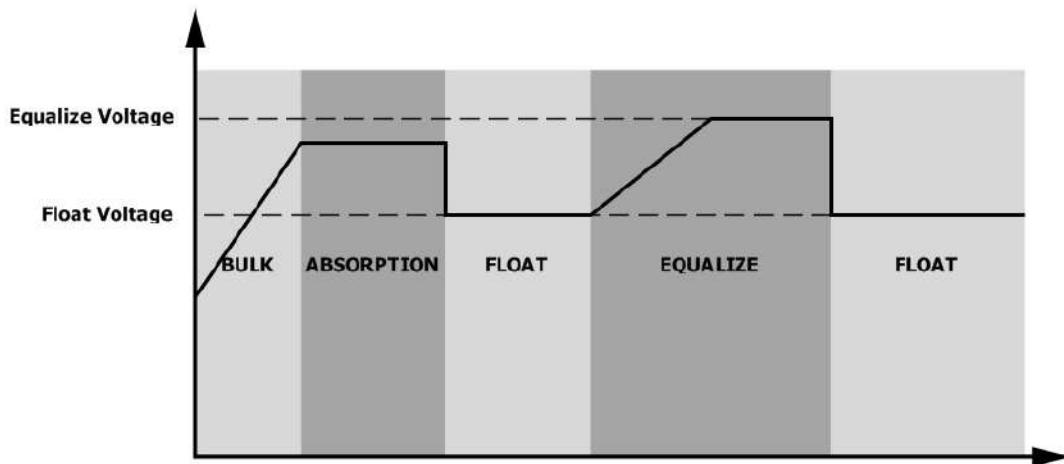

- **Equalize charging time and timeout**

In Equalize stage, the controller will supply power to charge battery as much as possible until battery voltage raises to battery equalization voltage. Then, constant-voltage regulation is applied to maintain battery voltage at the battery equalization voltage. The battery will remain in the Equalize stage until setting battery equalized time is arrived.

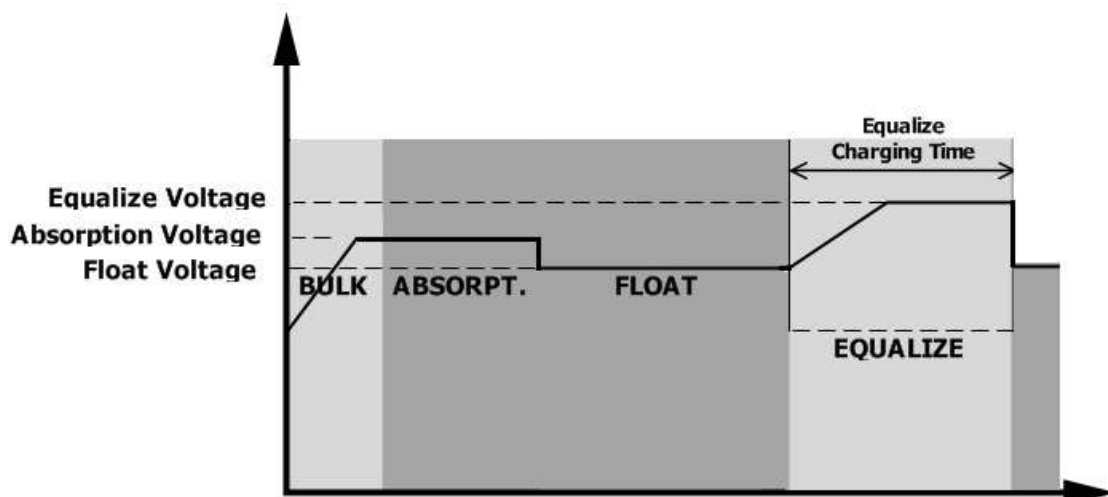

However, in Equalize stage, when battery equalized time is expired and battery voltage doesn't rise to battery equalization voltage point, the charge controller will extend the battery equalized time until battery voltage achieves battery equalization voltage. If battery voltage is still lower than battery equalization voltage when battery equalized timeout setting is over, the charge controller will stop equalization and return to float stage.

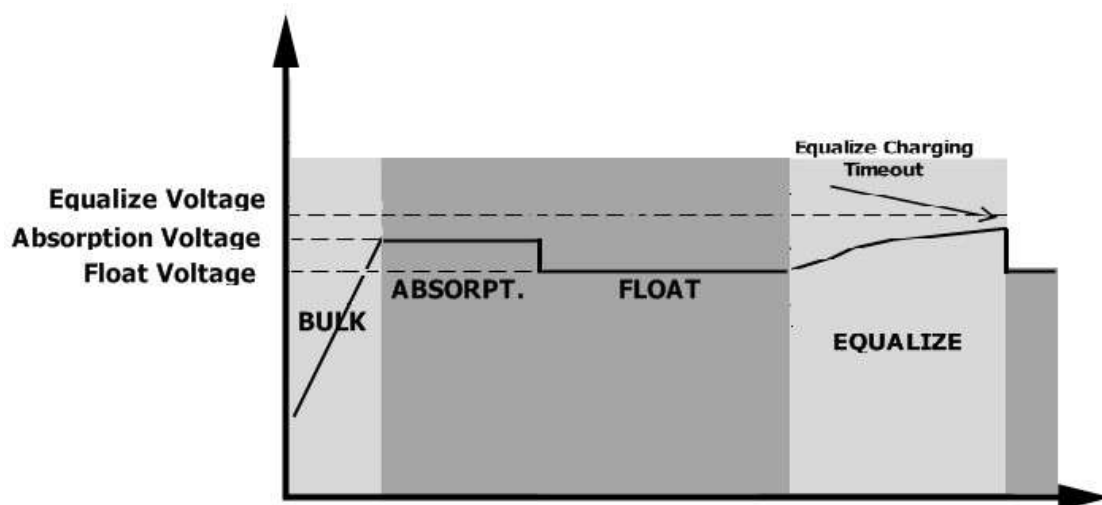

SPECIFICATIONS

Table 1 Line Mode Specifications

| INVERTER MODEL | 5KW | 6KW |
|---------------------------------|-----------------------------------------------------------------|-----|
| Input Voltage Waveform | Sinusoidal | |
| Nominal Input Voltage | 230Vac | |
| Low Loss Voltage | 110Vac±7V | |
| Low Loss Return Voltage | 120Vac±7V | |
| High Loss Voltage | 280Vac±7V | |
| High Loss Return Voltage | 270Vac±7V | |
| Max AC Input Voltage | 300Vac | |
| Nominal Input Frequency | 50Hz / 60Hz (Auto detection) | |
| Low Loss Frequency | 46(56)±1Hz | |
| Low Loss Return Frequency | 46.5(57)±1Hz | |
| High Loss Frequency | 54(64)±1Hz | |
| High Loss Return Frequency | 53(63)±1Hz | |
| Power Factor | >0.98 | |
| Output Short Circuit Protection | Line mode: Circuit Breaker Battery mode: Electronic Circuits | |
| Efficiency (Line Mode) | 93% (Peak Efficiency) | |
| Transfer Time | Line mode←→Battery mode 0ms Inverter←→Bypass 4ms | |

Table 2 Battery Mode Specifications

| INVERTER MODEL | 5KW | 6KW |
|----------------------------------------------------------------------|-------------------------------------------------------|------------|
| Rated Output Power | 5KVA/5KW | 6KV/6KW |
| Output Voltage Waveform | Pure Sine Wave | |
| Output Voltage Regulation | 230Vac±5% | |
| Output Frequency | 50Hz or 60Hz | |
| Peak Efficiency | 92% | |
| Overload Protection | 5s@≥150% load; 10s@110%~150% load; 100ms @ ≥200% load | |
| Surge Capacity | 2* rated power for 5 seconds | |
| Nominal DC Input Voltage | 48Vdc | |
| Operating Range | 40Vdc -66Vdc | |
| Cold Start Voltage | 46Vdc | |
| Low DC Warning Voltage @ load < 50% @ load ≥ 50% | 45.0Vdc 44.0Vdc | |
| Low DC Warning Return Voltage @ load < 50% @ load ≥ 50% | 47.0Vdc 46.0Vdc | |
| Low DC Cut-off Voltage @ load < 50% @ load ≥ 50% | 43.0Vdc 42.0Vdc | |
| High DC Recovery Voltage | 64Vdc | |
| High DC Cut-off Voltage | 66Vdc | |
| No Load Power Consumption | <75W | |

Table 3 Charge Mode Specifications

| Charging Mode | | | |
|---------------------------------------------|-----------------------------------------------------------------------------------------------------------------------------------------------------------------------------------------------------------------------------------------------------------------------------------------------------------------------------------------------------------------------------------------------------------------------------------------------------------------------------------------------------------------------|-------------------------|-------------------------|
| INVERTER MODEL | 5KW | 6KW | |
| Charging Current @ Nominal Input Voltage | | Default: 30A, max: 100A | Default: 60A, max: 120A |
| Bulk Charging Voltage | Flooded Battery | 58.4Vdc | |
| | AGM / Gel Battery | 56.4Vdc | |
| Floating Charging Voltage | | 54Vdc | |
| Overcharge Protection | | 66Vdc | |
| Charging Algorithm | | 3-Step | |
| Charging Curve | <p>The graph illustrates the 3-step charging process. The left y-axis represents Battery Voltage per cell (2.43Vdc to 2.25Vdc), and the right y-axis represents Charging Current (%). The x-axis is Time. The Bulk stage (T0) shows a linear increase in voltage and constant current. The Absorption stage (T1) shows constant voltage and a decreasing current. The Maintenance stage shows constant voltage and current. A note specifies T1 = 10 * T0, with a minimum of 10 minutes and a maximum of 8 hours.</p> | | |

Table 4 Solar Specifications

| Solar Input (MPPT type) | | |
|------------------------------------|----------|-------|
| INVERTER MODEL | 5KW | 6KW |
| Rated Power | 6000W | 7000W |
| Max. PV Array Open Circuit Voltage | 500Vdc | |
| PV Array MPPT Voltage Range | 120~430V | |
| Maximum solar input current | 27A | |

Table 4 ECO/Bypass Mode Specifications

| Bypass Mode | | |
|-----------------------------------|------------------------------|------------|
| INVERTER MODEL | 5KW | 6KW |
| Input Voltage Waveform | Sinusoidal | |
| Low Loss Voltage | 176Vac±7V | |
| Low Loss Return Voltage | 186Vac±7V | |
| High Loss Voltage | 280Vac±7V | |
| High Loss Return Voltage | 270Vac±7V | |
| Nominal Input Frequency | 50Hz / 60Hz (Auto detection) | |
| Low Loss Frequency | 46(56)±1Hz | |
| Low Loss Return Frequency | 46.5(57)±1Hz | |
| High Loss Frequency | 54(64)±1Hz | |
| High Loss Return Frequency | 53(63)±1Hz | |

Table 5 General Specifications

| INVERTER MODEL | 5KW | 6KW |
|------------------------------------|----------------------------------------------|------------|
| SCC type | MPPT | |
| Parallel-able | YES | |
| Communication | RS232 and Wi-Fi | |
| Safety Certification | CE | |
| Operating Temperature Range | -10°C to 50°C | |
| Storage temperature | -15°C~ 60°C | |
| Humidity | 5% to 95% Relative Humidity (Non-condensing) | |
| Dimension (D*W*H), mm | 140 x 295 x 468 | |
| Net Weight, kg | 12 | |

TROUBLE SHOOTING

| Problem | LCD/LED/Buzzer | Explanation / Possible cause | What to do |
|-------------------------------------------------------------------------------|-------------------------------------------------------------------------|---------------------------------------------------------------------------------------------------|------------------------------------------------------------------------------------------------------------------------------------------------------------------------|
| Unit shuts down automatically during startup process. | LCD/LEDs and buzzer will be active for 3 seconds and then complete off. | The battery voltage is too low (<1.91V/Cell) | 1. Re-charge battery. 2. Replace battery. |
| No response after power on. | No indication. | 1. The battery voltage is far too low. (<1.4V/Cell) 2. Battery polarity is connected reversed. | 1. Check if batteries and the wiring are connected well. 2. Re-charge battery. 3. Replace battery. |
| Mains exist but the unit works in battery mode. | Input voltage is displayed as 0 on the LCD and green LED is flashing. | Input protector is tripped | Check if AC breaker is tripped and AC wiring is connected well. |
| | Green LED is flashing. | Insufficient quality of AC power. (Shore or Generator) | 1. Check if AC wires are too thin and/or too long. 2. Check if generator (if applied) is working well or if input voltage range setting is correct. (UPS→Appliance) |
| When the unit is turned on, internal relay is switched on and off repeatedly. | LCD display and LEDs are flashing | Battery is disconnected. | Check if battery wires are connected well. |
| Buzzer beeps continuously and red LED is on. | Fault code 07 | Overload error. The inverter is overload 110% and time is up. | Reduce the connected load by switching off some equipment. |
| | Fault code 05 | Output short circuited. | Check if wiring is connected well and remove abnormal load. |
| | Fault code 02 | Internal temperature of inverter component is over 100°C. | Check whether the air flow of the unit is blocked or whether the ambient temperature is too high. |
| | Fault code 03 | Battery is over-charged. | Return to repair center. |
| | | The battery voltage is too high. | Check if spec and quantity of batteries are meet requirements. |
| | Fault code 01 | Fan fault | Replace the fan. |
| | Fault code 06/58 | Output abnormal (Inverter voltage below than 190Vac or is higher than 260Vac) | 1. Reduce the connected load. 2. Return to repair center |
| | Fault code 08/09/53/57 | Internal components failed. | Return to repair center. |
| | Fault code 50 | PFC over current or surge. | Restart the unit, if the error happens again, please return to repair center. |
| | Fault code 51 | OP over current or surge. | |
| | Fault code 52 | Bus voltage is too low. | |
| Fault code 55 | Output voltage is unbalanced. | | |
| Fault code 56 | Battery is not connected well or fuse is burnt. | If the battery is connected well, please return to repair center. | |

PARALLEL FUNCTION

1. Introduction

This inverter can be used in parallel for two applications.

1. Parallel operation in single phase with up to 9 units. For 5KW model, the supported maximum output power is 45KW/45KVA. For 6KW model, the supported maximum output power is 54KW/54KVA.
2. Maximum 9 units work together to support three-phase equipment. Seven units support one phase maximum. For 5KW model, the supported maximum output power is 45KW/45KVA and one phase can be up to 35KW/35KVA. For 6KW model, the supported maximum output power is 54KW/54KVA and one phase can be up to 42KW/42KVA.

NOTE: If this unit is bundled with share current cable and parallel cable, this inverter is default supported parallel operation. You may skip section 3. If not, please purchase parallel kit and install this unit by following instruction from professional technical personnel in local dealer.

ATTENTION: Parallel configuration of the inverter needs to be done with only AC grid IN connected and parallel cable not installed, if not this could cause the brake of the inverter showing ERROR F09 and will not be covered by warranty. After the configuration of menu 28, inverter needs to be turned off. You will then procede to the same configuration of the additional inverter following the same procedure. When all inverter are off and configured you can procede to final cabling and then turn everything ON

2. Package Contents

In parallel kit, you will find the following items in the package:

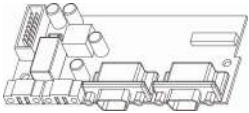

Parallel board

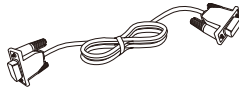

Parallel communication cable



Current sharing cable

3. Parallel board installation

Step 1: Remove bottom case by unscrewing all screws as shown below.

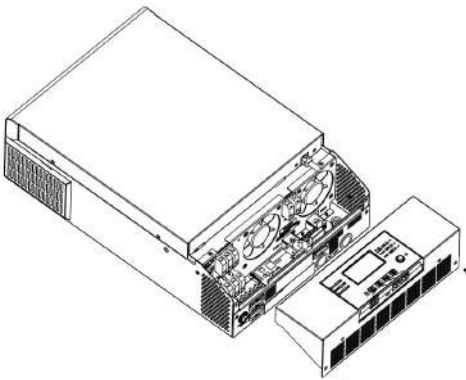

Step 2: Remove two screws as below chart and remove 2-pin and 14-pin cables.

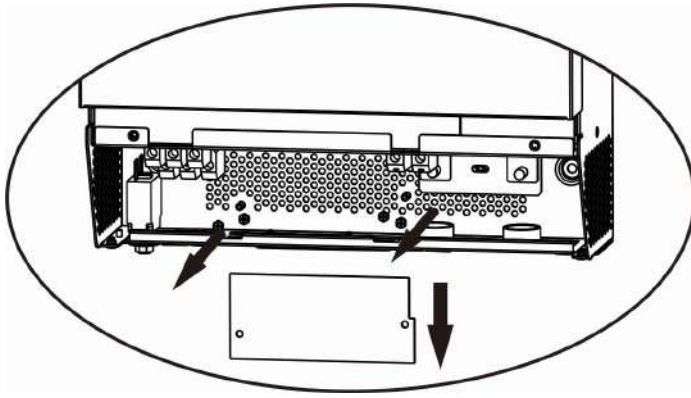

Step 3: Remove two screws as below chart to take out cover of parallel communication.

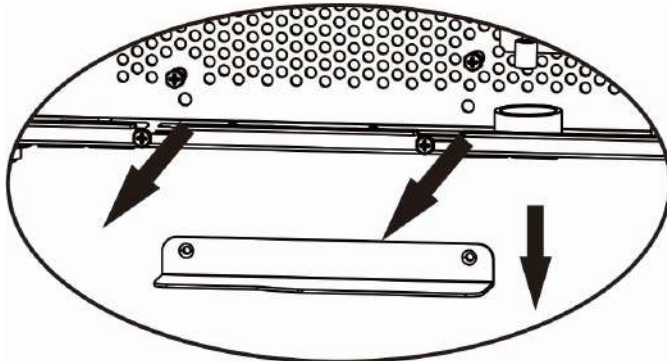

Step 4: Install new parallel board with 2 screws tightly.

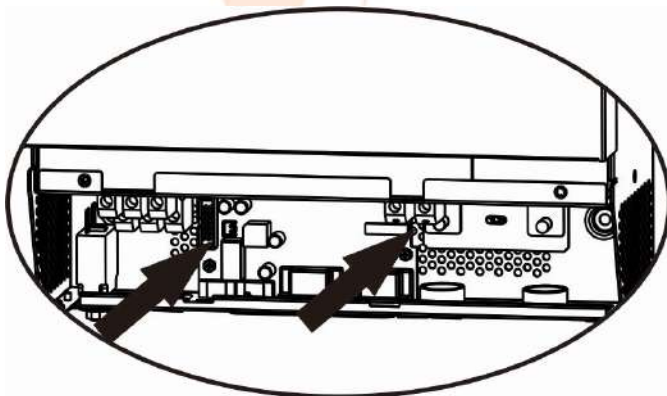

Step 5: Re-connect 2-pin and 14-pin to original position on parallel board as shown below chart.

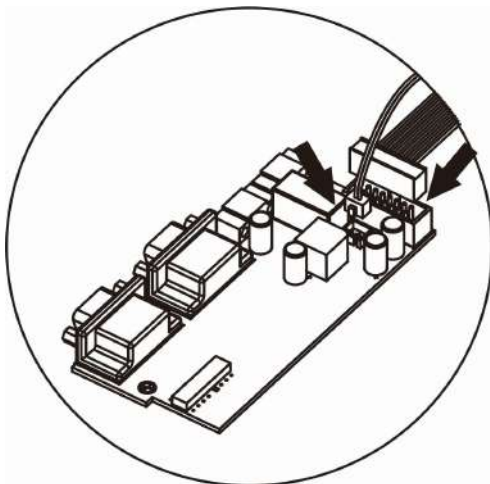

Step 6: Put wire cover back to the unit. Now the inverter is providing parallel operation function.



4. Mounting the Unit

When installing multiple units, please follow below chart.

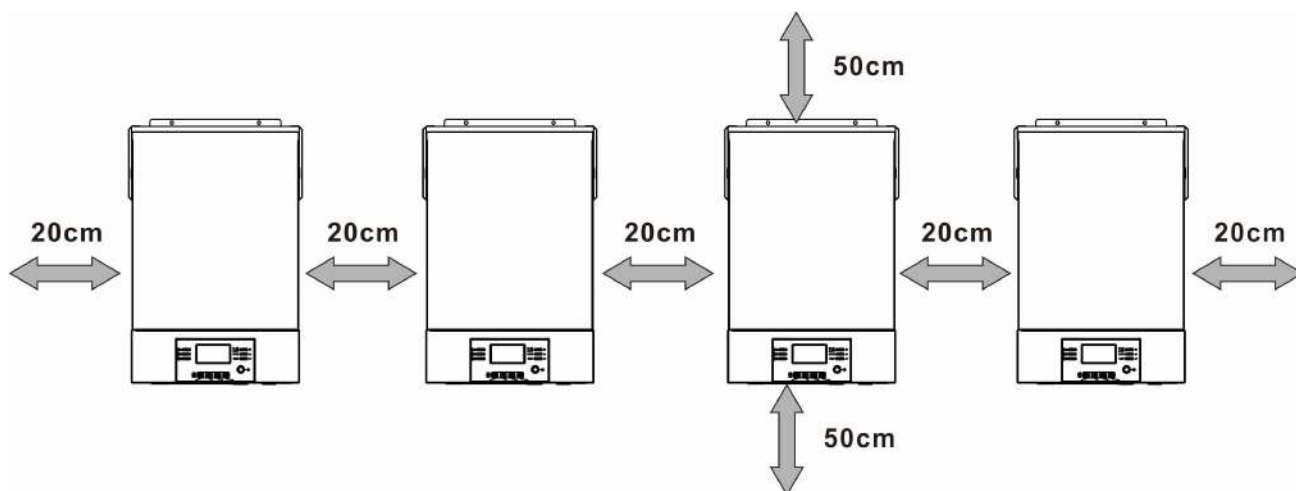

NOTE: For proper air circulation to dissipate heat, allow a clearance of approx. 20 cm to the side and approx. 50 cm above and below the unit. Be sure to install each unit in the same level.

5. Wiring Connection

The cable size of each inverter is shown as below:

Recommended battery cable and terminal size for each inverter:

| Model | Wire Size | Ring Terminal | | | Torque value |
|---------|-----------|-----------------------|------------|--------|--------------|
| | | Cable mm ² | Dimensions | | |
| | | | D (mm) | L (mm) | |
| 5KW/6KW | 1*1/0AWG | 60 | 6.4 | 49.7 | 2~3 Nm |
| | 2 * 4AWG | 44 | 6.4 | 49.7 | |

Ring terminal:

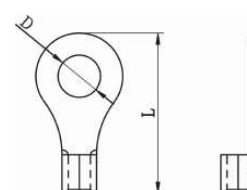

WARNING: Be sure the length of all battery cables is the same. Otherwise, there will be voltage difference between inverter and battery to cause parallel inverters not working.

Recommended AC input and output cable size for each inverter:

| Model | AWG no. | Torque |
|---------|---------|-----------|
| 5KW/6KW | 8 AWG | 1.4~1.6Nm |

You need to connect the cables of each inverter together. Take the battery cables for example: You need to use a connector or bus-bar as a joint to connect the battery cables together, and then connect to the battery terminal. The cable size used from joint to battery should be X times cable size in the tables above. "X" indicates the number of inverters connected in parallel.

Regarding AC input and output, please also follow the same principle.

CAUTION!! Please install the breaker at the battery and AC input side. This will ensure the inverter can be securely disconnected during maintenance and fully protected from over current of battery or AC input. The recommended mounted location of the breakers is shown in the figures in 5-1 and 5-2.

Recommended breaker specification of battery for each inverter:

| | |
|-------|------------|
| Model | 1 unit* |
| 5KW | 125A/80VDC |
| 6KW | 150A/80VDC |

*If you want to use only one breaker at the battery side for the whole system, the rating of the breaker should be X times current of 1 unit. "X" indicates the number of inverters connected in parallel.

Recommended breaker specification of AC input:

| Model | 2 units | 3 units | 4 units | 5 units | 6 units | 7 units | 8 units | 9 units |
|---------|---------|---------|---------|---------|---------|---------|---------|---------|
| 5KW/6KW | 100A | 150A | 200A | 250A | 300A | 350A | 400A | 450A |

Note1: Also, you can use 40A for only 1 unit and install one breaker at its AC input in each inverter.

Note2: Regarding three-phase system, you can use 4-pole breaker directly and the rating of the breaker should be compatible with the phase current limitation from the phase with maximum units

Recommended battery capacity

| Inverter parallel numbers | 2 | 3 | 4 | 5 | 6 | 7 | 8 | 9 |
|---------------------------|-------|--------|--------|--------|--------|--------|--------|--------|
| Battery Capacity | 800AH | 1200AH | 1600AH | 2000AH | 2400AH | 2800AH | 3200AH | 3600AH |

WARNING! Be sure that all inverters will share the same battery bank. Otherwise, the inverters will transfer to fault mode.

5-1. Parallel Operation in Single phase

Two inverters in parallel:

Power Connection

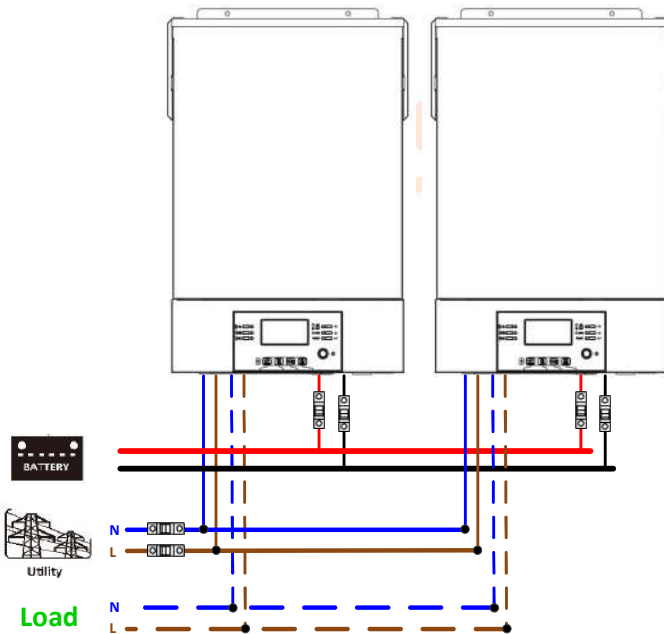

Communication Connection

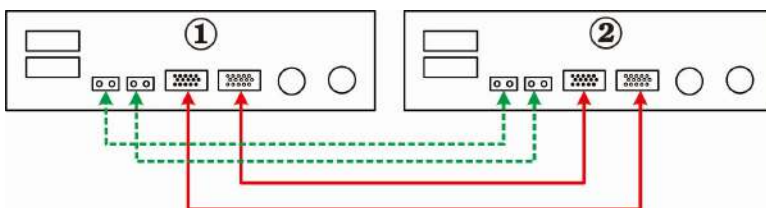

Three inverters in parallel:

Power Connection

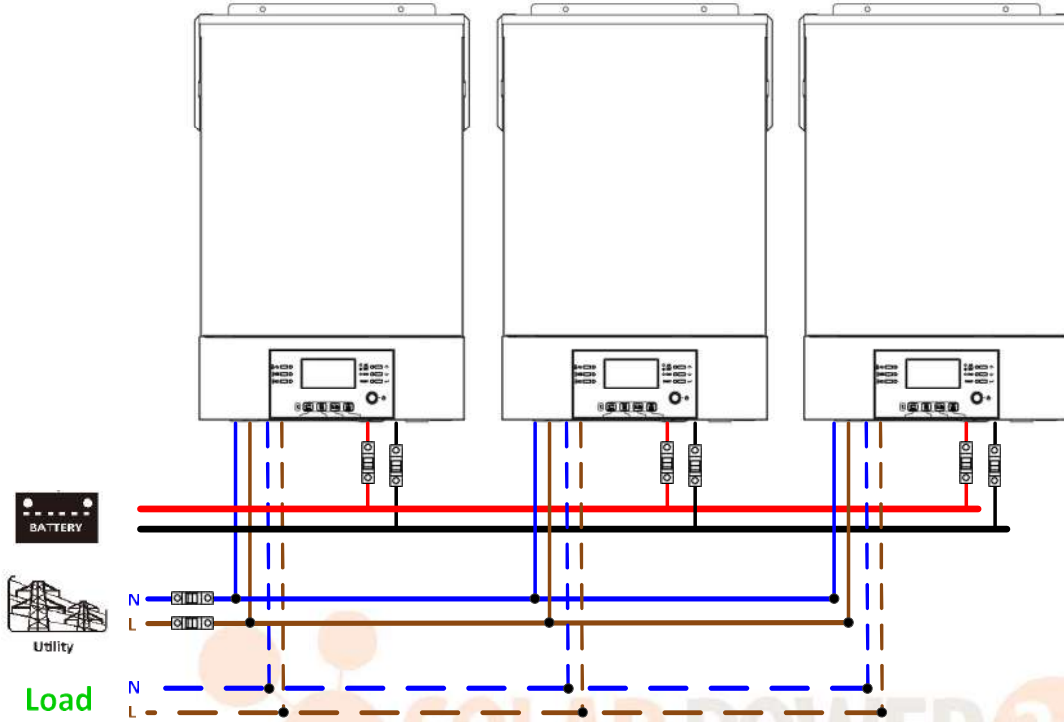

Communication Connection

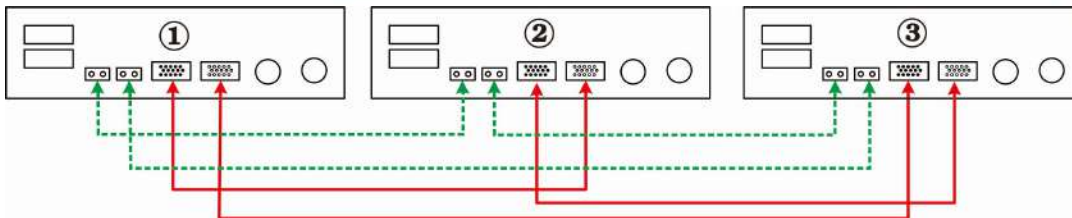

Four inverters in parallel:

Power Connection

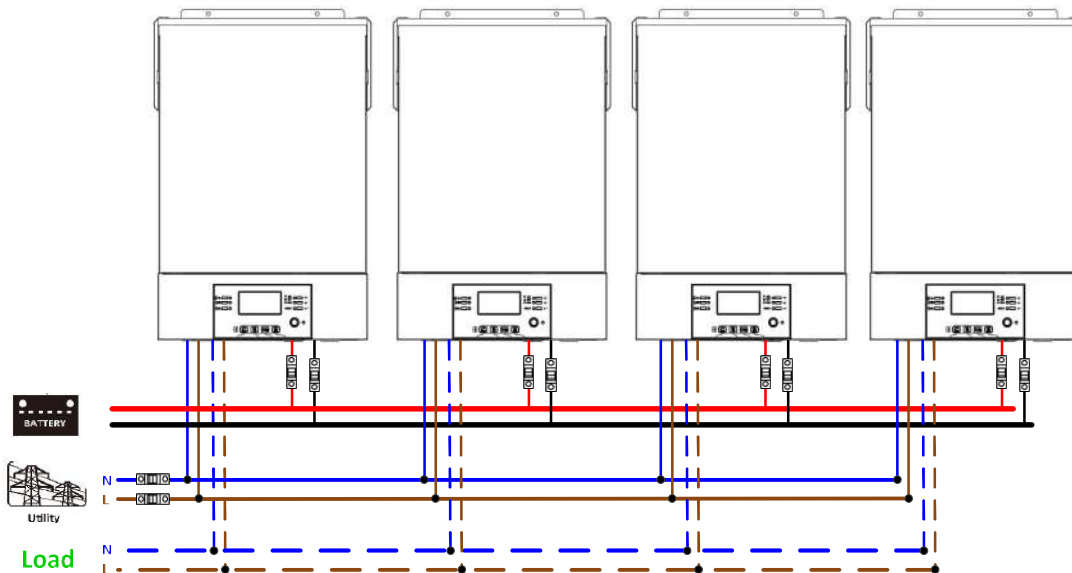

Communication Connection

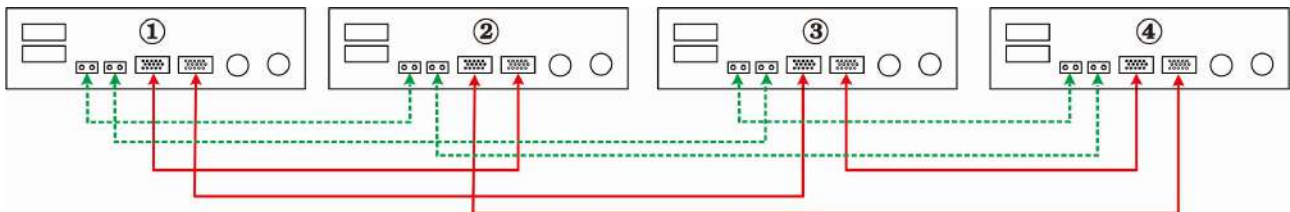

Five inverters in parallel:

Power Connection

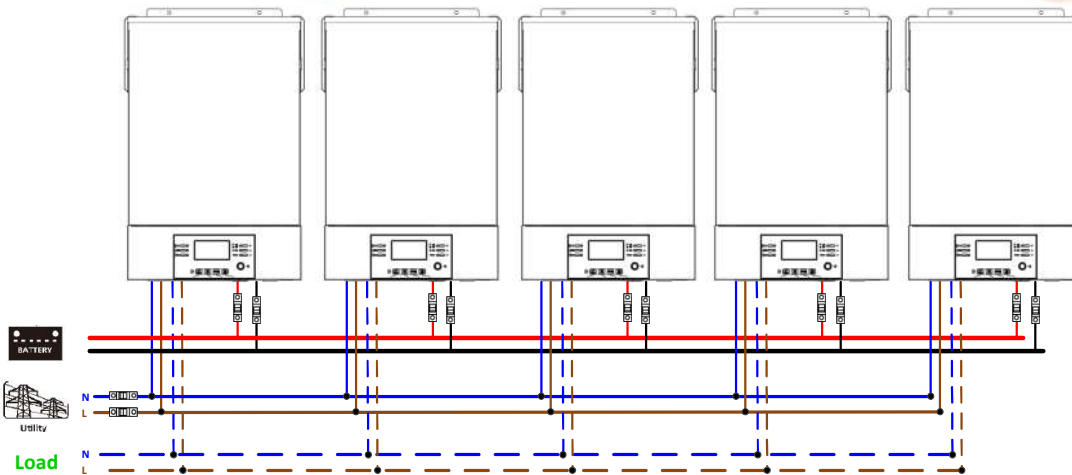

Communication Connection

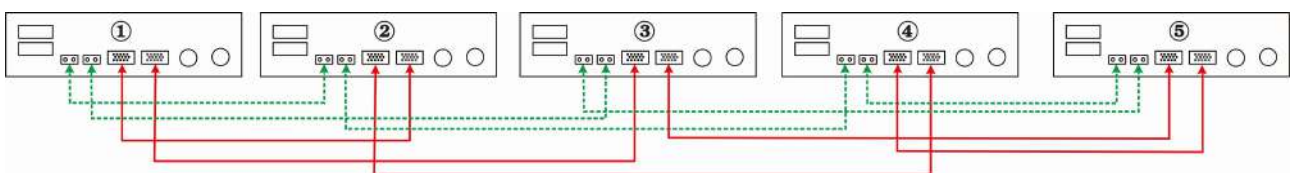

Six inverters in parallel:

Power Connection

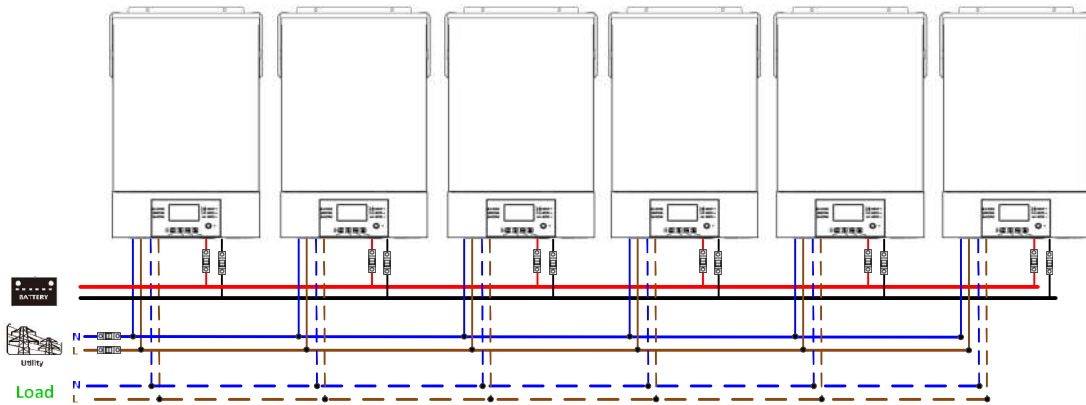

Communication Connection

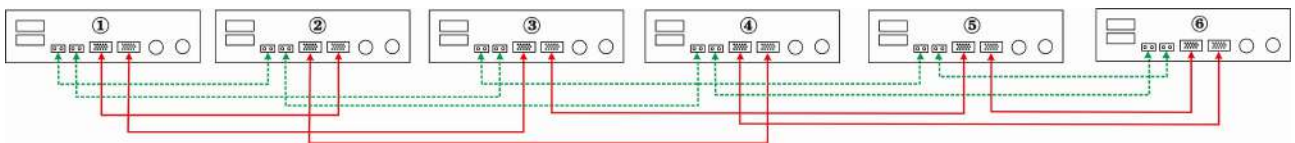

Seven to nine inverters in parallel:

Power Connection

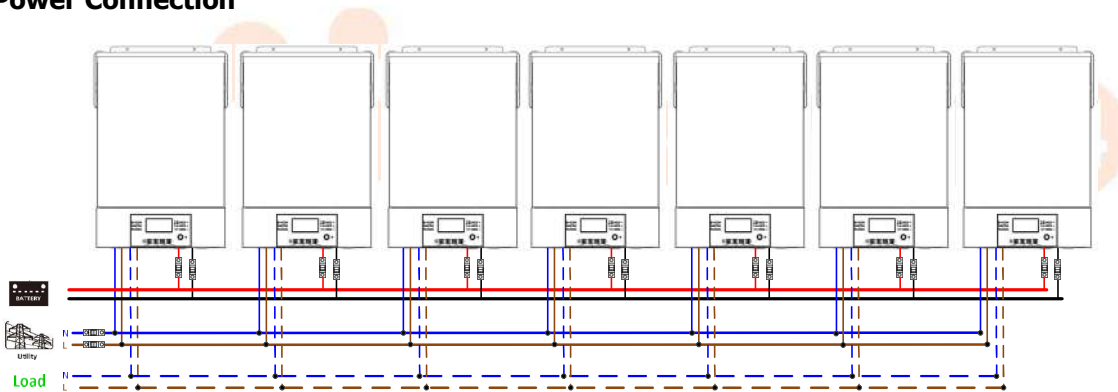

Communication Connection

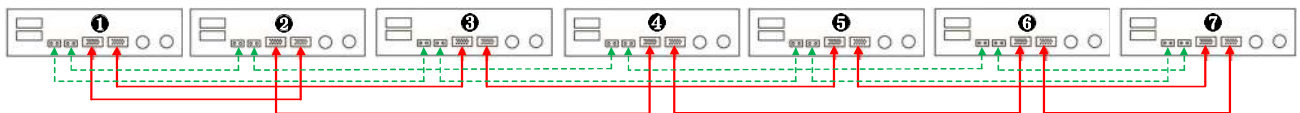

Eight to nine inverters in parallel:

Power Connection

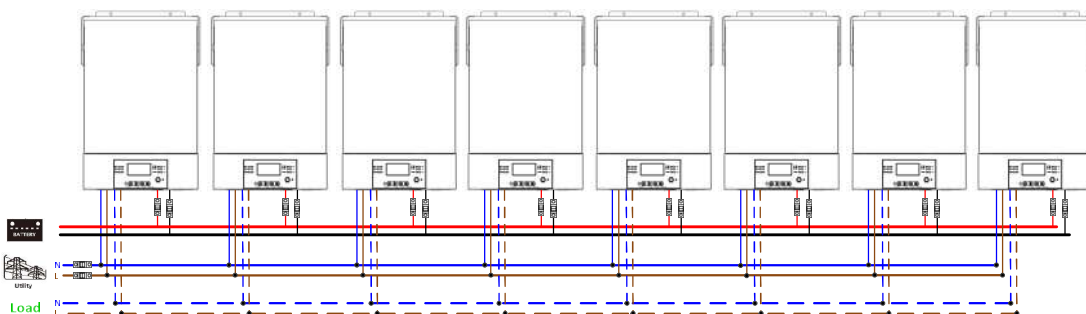

Communication Connection



Nine to nine inverters in parallel:

Power Connection

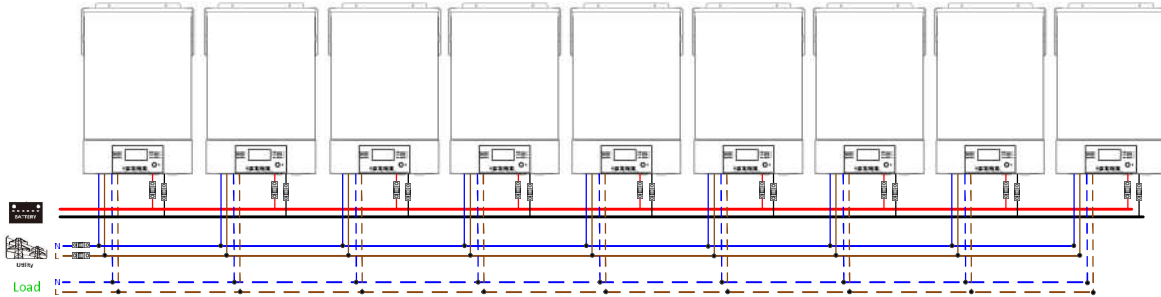

Communication Connection

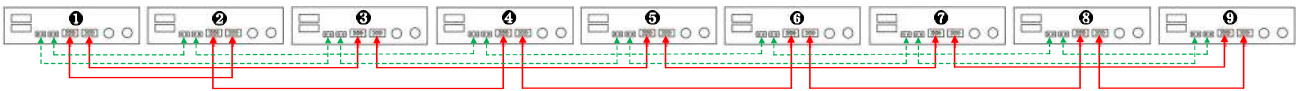

5-2. Support 3-phase equipment

Three inverters in each phase:

Power Connection

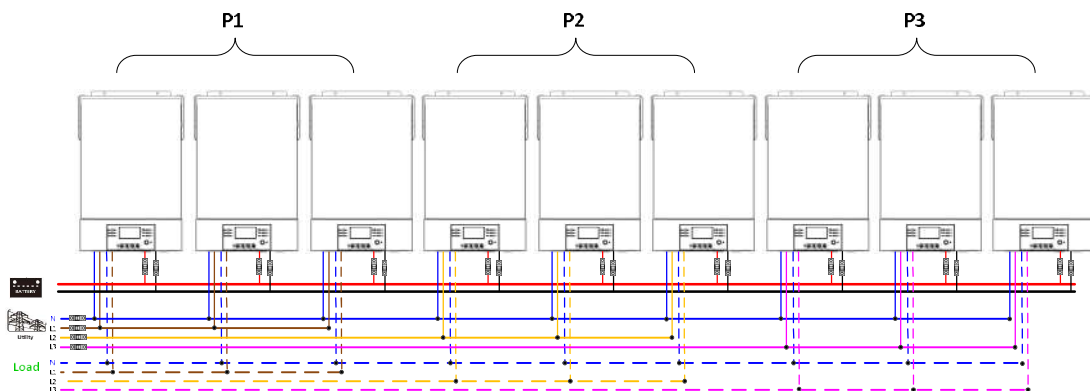

Communication Connection

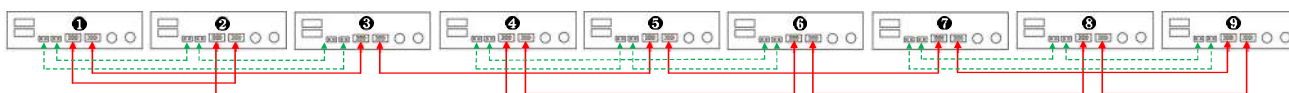

Three inverters in one phase, three inverters in second phase and two inverter for the third phase:

Power Connection

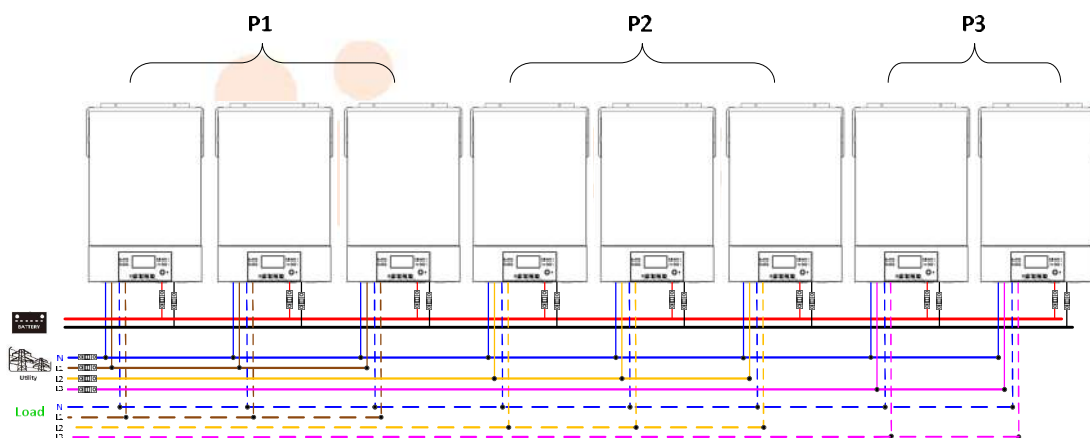

Communication Connection



Seven inverters in one phase and one inverter for the other two phases:

Power Connection

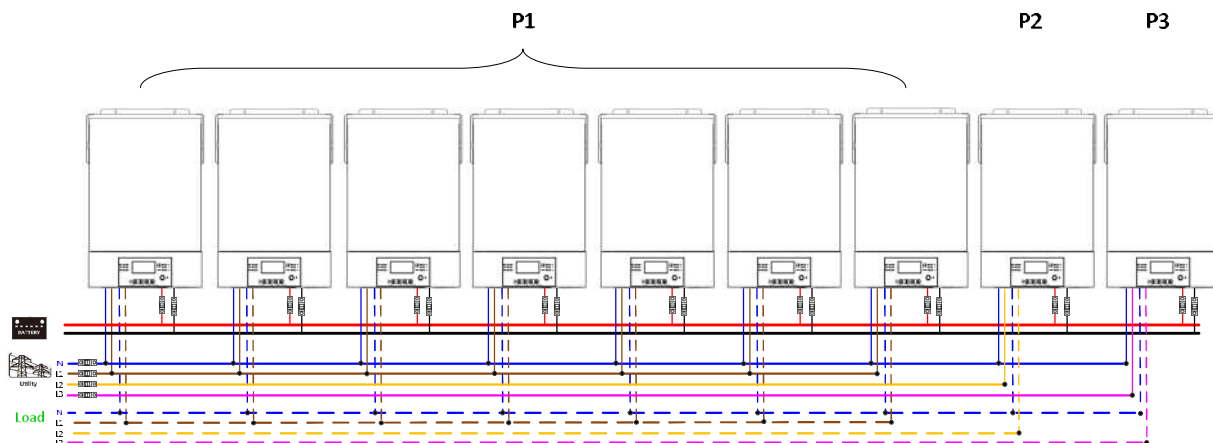

Note: It's up to customer's demand to pick 7 inverters on any phase.

P1: L1-phase, P2: L2-phase, P3: L3-phase.

Communication Connection

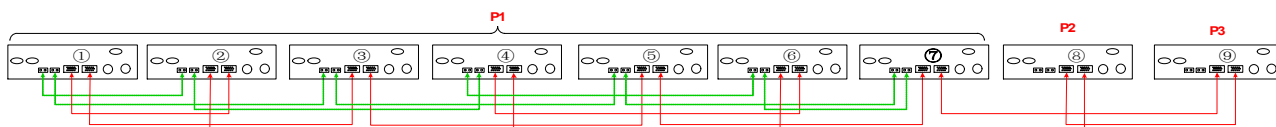

Note: If there is only one unit in one phase, this unit doesn't need to connect the current sharing cable.

Or you connect it like as below:

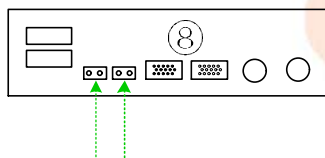

Three inverters in one phase, two inverters in second phase and two inverters for the third phase:

Power Connection

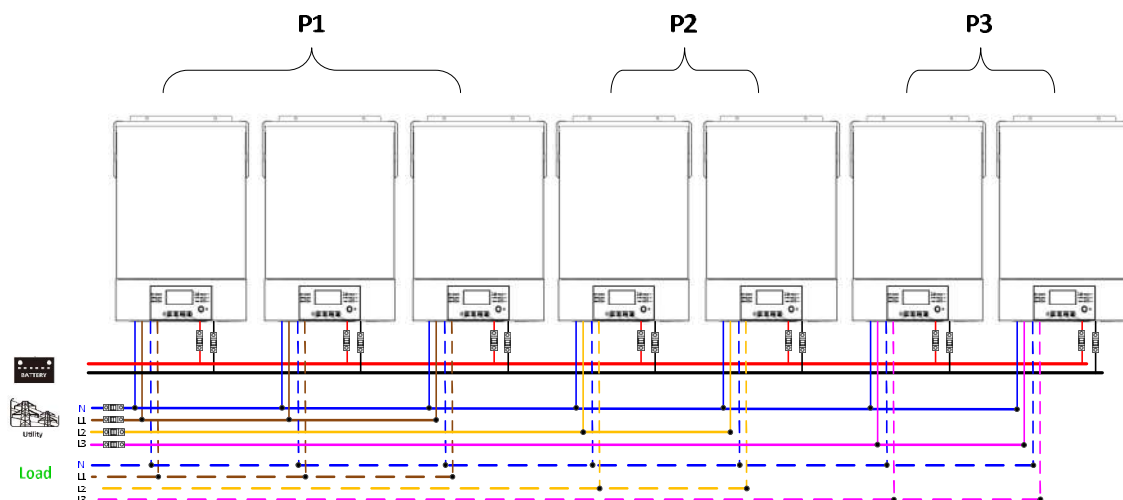

Communication Connection

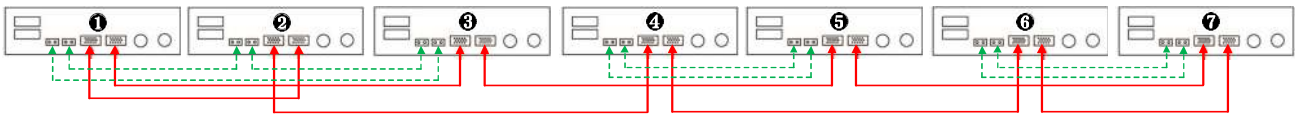

Two inverters in each phase:

Power Connection

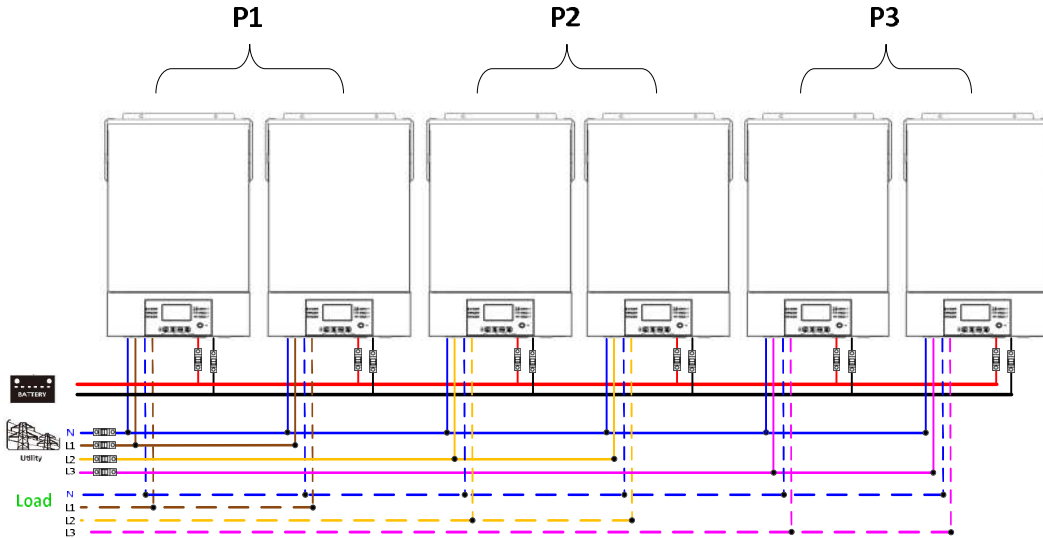

Communication Connection

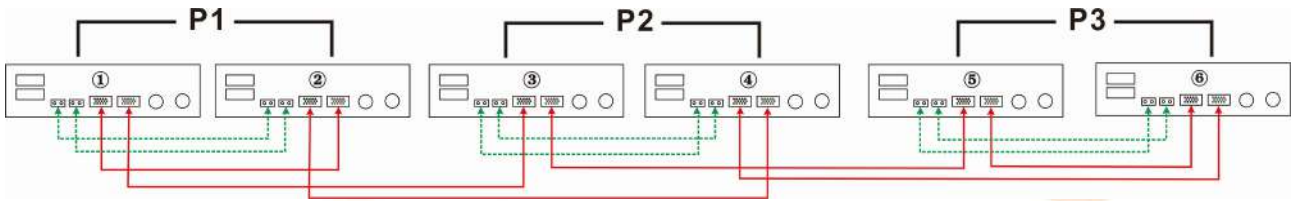

Four inverters in one phase and one inverter for the other two phases:

Power Connection

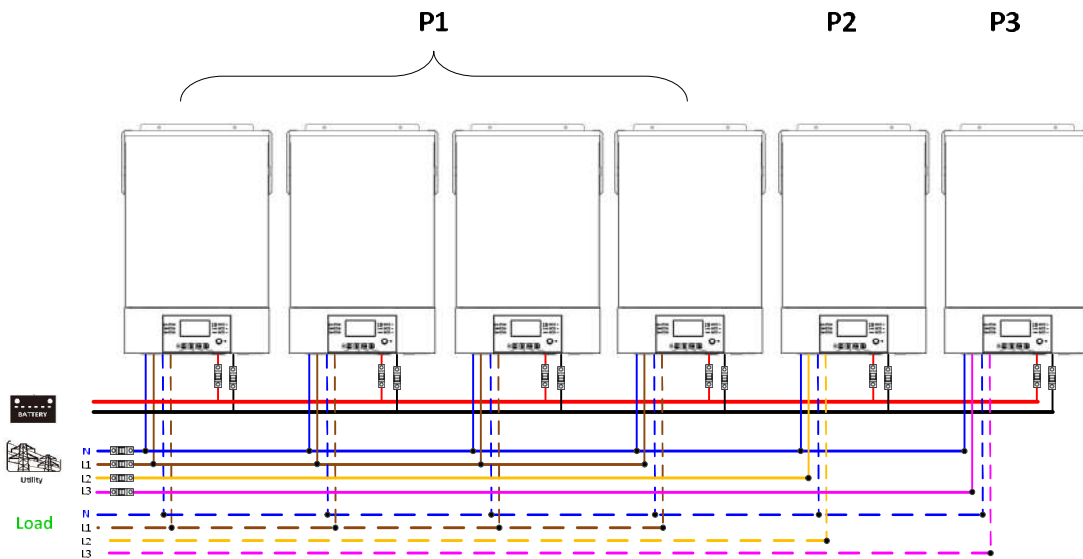

Communication Connection

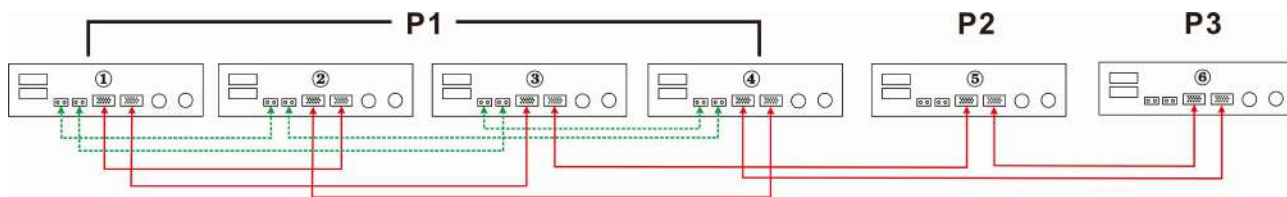

Three inverters in one phase, two inverters in second phase and one inverter for the third phase:

Power Connection

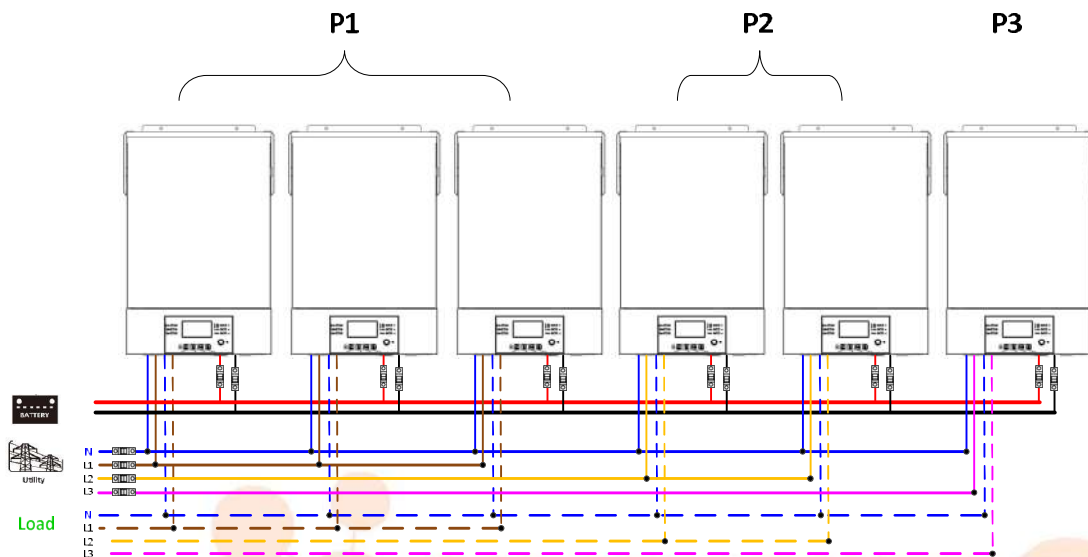

Communication Connection

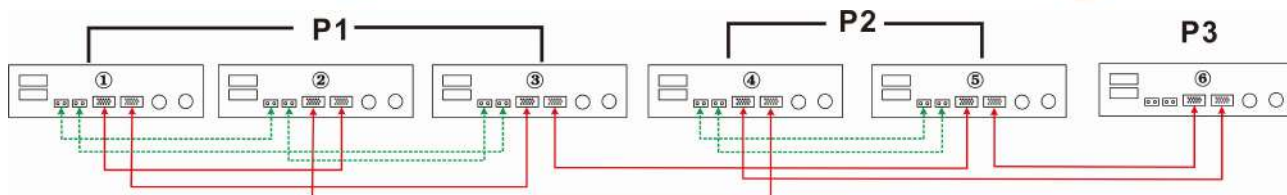

Three inverters in one phase and only one inverter for the remaining two phases:

Power Connection

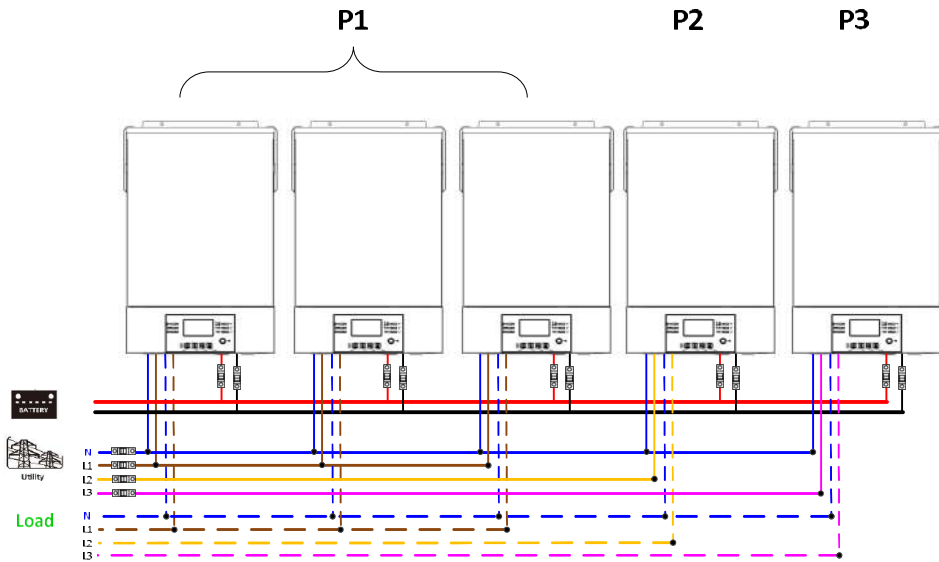

Communication Connection

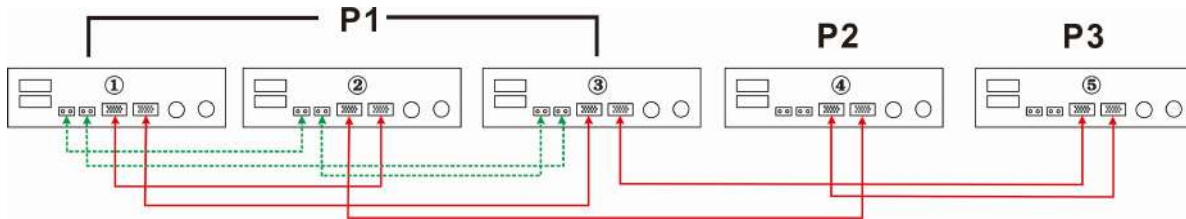

Two inverters in two phases and only one inverter for the remaining phase:

Power Connection

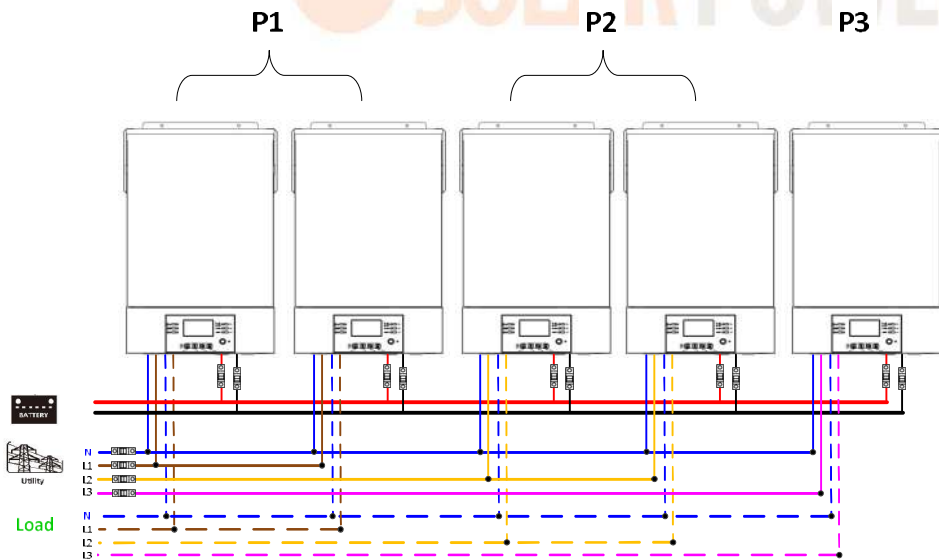

Communication Connection

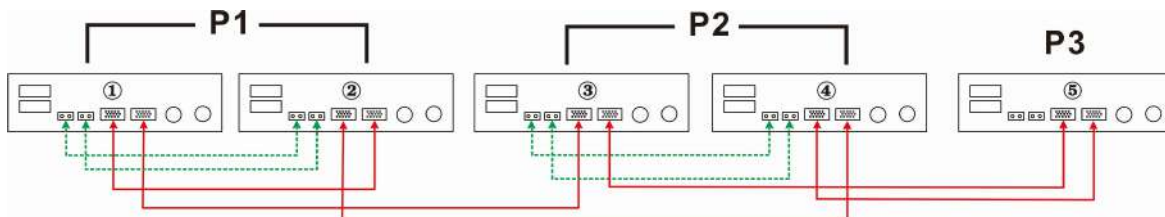

Two inverters in one phase and only one inverter for the remaining phases:

Power Connection

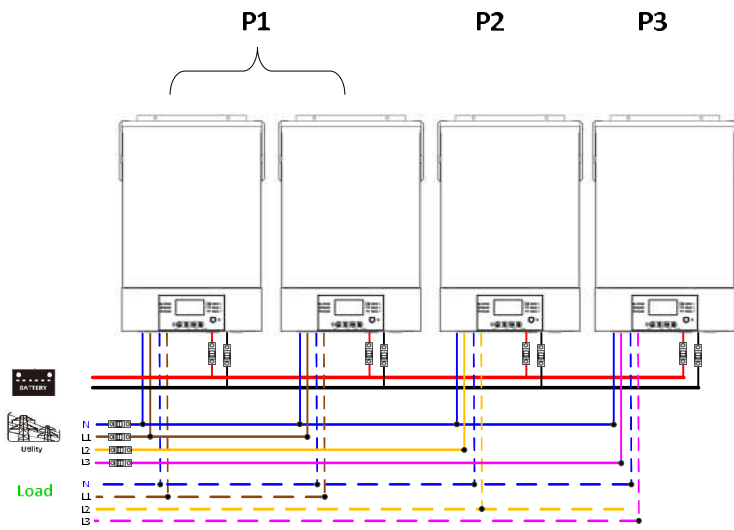

Communication Connection

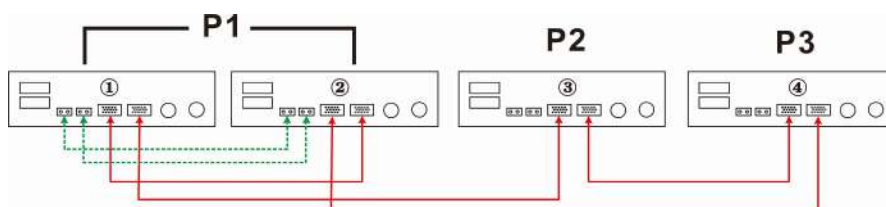

One inverter in each phase:

Power Connection

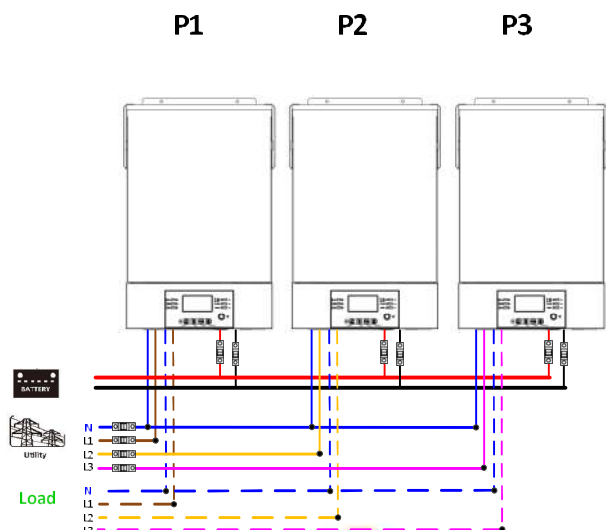

Communication Connection

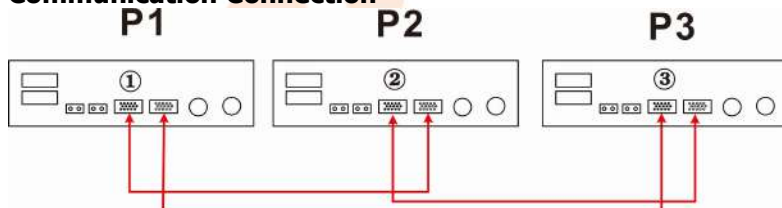

WARNING: Do not connect the current sharing cable between the inverters which are in different phases. Otherwise, it may damage the inverters.





6. PV Connection

Please refer to user manual of single unit for PV Connection.

CAUTION: Each inverter should connect to PV modules separately.

7. LCD Setting and Display

Setting Program:

| Program | Description | Selectable option | |
|-----------------------------------------------------------------------------------------------------|---------------------------------------------------------------------------------------------------------------------------------------------|---------------------------------------------------------------------------------------------------|-------------------------------------------------------------------------------------------------------------------------------------------------------------------------------------------------------------------------------------------------------------------------------------------------------------------------------------------------------------------------------------------------------------------------------------------------------------------------------------------------------------------------------------------------------------------------|
| 28 | AC output mode *This setting is able to set up only when the inverter is in standby mode. Be sure that on/off switch is in "OFF" status. | Single 28  | When the unit is operated alone, please select "SIG" in program 28. |
| | | SIG | |
| | | Parallel 28  | When the units are used in parallel for single phase application, please select "PAL" in program 28. Please refer to 5-1 for detailed information. |
| | | PAL | |
| | | L1 phase: 28  | When the units are operated in 3-phase application, please choose "3PX" to define each inverter. It is required to have at least 3 inverters or maximum 9 inverters to support three-phase equipment. It's required to have at least one inverter in each phase or it's up to four inverters in one phase. Please refers to 5-2 for detailed information. Please select "3P1" in program 28 for the inverters connected to L1 phase, "3P2" in program 28 for the inverters connected to L2 phase and "3P3" in program 28 for the inverters connected to L3 phase. |
| L2 phase: 28  | | | |
| L3 phase: 28  | | | |
| | | 3P1 3P2 3P3 | Be sure to connect share current cable to units which are on the same phase. Do NOT connect share current cable between units on different phases. |

Fault code display:

| Fault Code | Fault Event | Icon on |
|------------|---------------------------------------------------|---------|
| 60 | Power feedback protection | F60 |
| 71 | Firmware version inconsistent | F71 |
| 72 | Current sharing fault | F72 |
| 80 | CAN fault | F80 |
| 81 | Host loss | F81 |
| 82 | Synchronization loss | F82 |
| 83 | Battery voltage detected different | F83 |
| 84 | AC input voltage and frequency detected different | F84 |
| 85 | AC output current unbalance | F85 |
| 86 | AC output mode setting is different | F86 |

8. Commissioning

Parallel in single phase

Step 1: Check the following requirements before commissioning:

- Correct wire connection
- Ensure all breakers in Line wires of load side are open and each Neutral wires of each unit are connected together.

Step 2: Turn on each unit and set "PAL" in LCD setting program 28 of each unit. And then shut down all units.

NOET: It's necessary to turn off switch when setting LCD program. Otherwise, the setting can not be programmed.

Step 3: Turn on each unit.

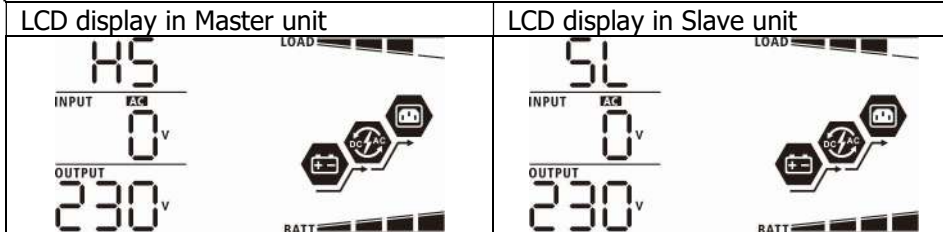

NOTE: Master and slave units are randomly defined.

Step 4: Switch on all AC breakers of Line wires in AC input. It's better to have all inverters connect to utility at the same time. If detecting AC connection, they will work normally.

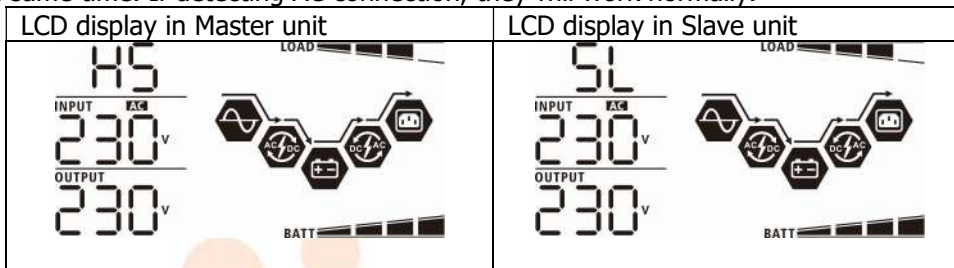

Step 5: If there is no more fault alarm, the parallel system is completely installed.

Step 6: Please switch on all breakers of Line wires in load side. This system will start to provide power to the load.

Support three-phase equipment

Step 1: Check the following requirements before commissioning:

- Correct wire connection
- Ensure all breakers in Line wires of load side are open and each Neutral wires of each unit are connected together.

Step 2: Turn on all units and configure LCD program 28 as P1, P2 and P3 sequentially. And then shut down all units.

NOET: It's necessary to turn off switch when setting LCD program. Otherwise, the setting can not be programmed.

Step 3: Turn on all units sequentially.

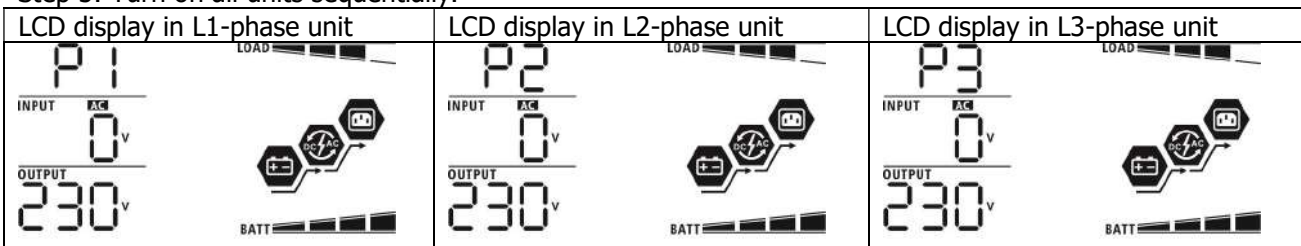

Step 4: Switch on all AC breakers of Line wires in AC input. If AC connection is detected and three phases are matched with unit setting, they will work normally. Otherwise, the AC icon will flash and they will not work in line mode.

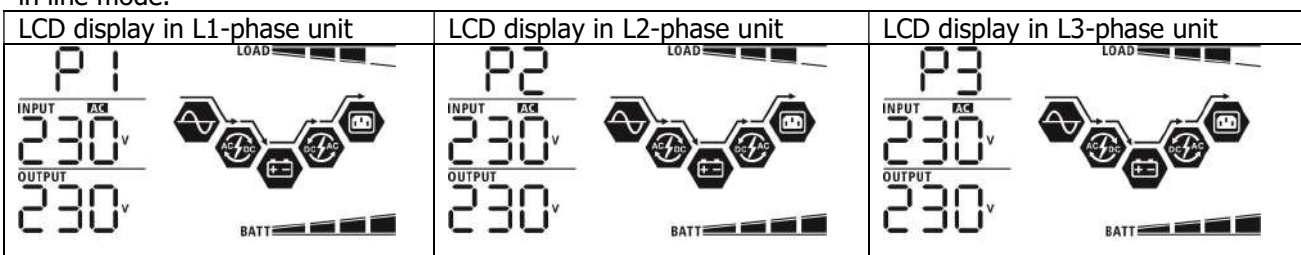

Step 5: If there is no more fault alarm, the system to support 3-phase equipment is completely installed.

Step 6: Please switch on all breakers of Line wires in load side. This system will start to provide power to the load.

Note 1: To avoid overload occurring, before turning on breakers in load side, it's better to have whole system in operation first.

Note 2: Transfer time for this operation exists. Power interruption may happen to critical devices, which cannot bear transfer time.

9. Trouble shooting

| Situation | | Solution |
|------------|--------------------------------------------------------|------------------------------------------------------------------------------------------------------------------------------------------------------------------------------------------------------------------------------------------------------------------------------------------------------------------------------------------------------------------------------------------------------------------------------------------------------------------------------------------------------------------------------------------|
| Fault Code | Fault Event Description | |
| 60 | Current feedback into the inverter is detected. | <ol style="list-style-type: none"> Restart the inverter. Check if L/N cables are not connected reversely in all inverters. For parallel system in single phase, make sure the sharing are connected in all inverters. For supporting three-phase system, make sure the sharing cables are connected in the inverters in the same phase, and disconnected in the inverters in different phases. If the problem remains, please contact your installer. |
| 71 | The firmware version of each inverter is not the same. | <ol style="list-style-type: none"> Update all inverter firmware to the same version. Check the version of each inverter via LCD setting and make sure the CPU versions are same. If not, please contact your installer to provide the firmware to update. After updating, if the problem still remains, please contact your installer. |
| 72 | The output current of each inverter is different. | <ol style="list-style-type: none"> Check if sharing cables are connected well and restart the inverter. If the problem remains, please contact your installer. |
| 80 | CAN data loss | <ol style="list-style-type: none"> Check if communication cables are connected well and restart the inverter. If the problem remains, please contact your installer. |
| 81 | Host data loss | |
| 82 | Synchronization data loss | |
| 83 | The battery voltage of each inverter is not the same. | <ol style="list-style-type: none"> Make sure all inverters share same groups of batteries together. Remove all loads and disconnect AC input and PV input. Then, check battery voltage of all inverters. If the values from all inverters are close, please check if all battery cables are the same length and same material type. Otherwise, please contact your installer to provide SOP to calibrate battery voltage of each inverter. If the problem still remains, please contact your installer. |
| 84 | AC input voltage and frequency are detected different. | <ol style="list-style-type: none"> Check the utility wiring connection and restart the inverter. Make sure utility starts up at same time. If there are breakers installed between utility and inverters, please be sure all breakers can be turned on AC input at same time. If the problem remains, please contact your installer. |
| 85 | AC output current unbalance | <ol style="list-style-type: none"> Restart the inverter. Remove some excessive loads and re-check load information from LCD of inverters. If the values are different, please check if AC input and output cables are in the same length and material type. If the problem remains, please contact your installer. |
| 86 | AC output mode setting is different. | <ol style="list-style-type: none"> Switch off the inverter and check LCD setting #28. For parallel system in single phase, make sure no 3P1, 3P2 or 3P3 is set on #28. For supporting three-phase system, make sure no "PAL" is set on #28. If the problem remains, please contact your installer. |

Appendix A: Approximate Back-up Time Table

| Model | Load (VA) | Backup Time @ 48Vdc 200Ah (min) | Backup Time @ 48Vdc 400Ah (min) |
|-------|-----------|---------------------------------|---------------------------------|
| 5KW | 500 | 1226 | 2576 |
| | 1000 | 536 | 1226 |
| | 1500 | 316 | 804 |
| | 2000 | 222 | 542 |
| | 2500 | 180 | 430 |
| | 3000 | 152 | 364 |
| | 3500 | 130 | 282 |
| | 4000 | 100 | 224 |
| | 4500 | 88 | 200 |
| | 5000 | 80 | 180 |

Note: Backup time depends on the quality of the battery, age of battery and type of battery.
Specifications of batteries may vary depending on different manufacturers.



Appendix B: BMS Communication Installation

1. Introduction

If connecting to lithium battery, it is recommended to purchase a custom-made RJ45 communication cable. Please check with your dealer or integrator for details.

This custom-made RJ45 communication cable delivers information and signal between lithium battery and the inverter. These information are listed below:

- Re-configure charging voltage, charging current and battery discharge cut-off voltage according to the lithium battery parameters.
- Have the inverter start or stop charging according to the status of lithium battery.

2. Lithium Battery Communication Configuration

PYLONTECH

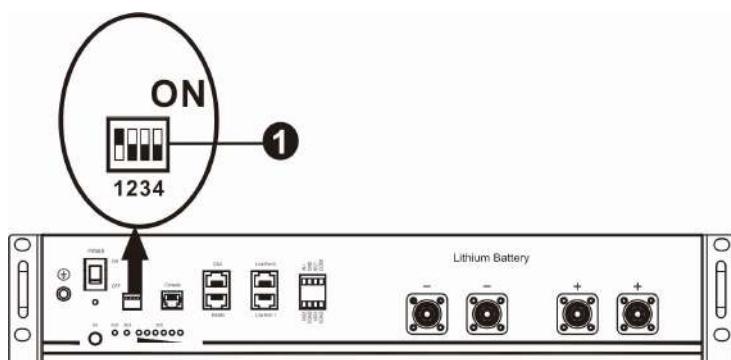

□ ADD Switch: There are 4 ADD switches are to define different baud rate and battery group address. If switch position is turned to bottom for "OFF" position, it means "0". If switch position is turned to upper for "ON" position, it means "1".

Dip 1 is "ON" to represent the baud rate 9600.

Dip 2, 3 and 4 are to set up battery group address.

Dip switch 2, 3 and 4 on master battery (first battery) are to set up or change the group address.

NOTE: "1" is upper position and "0" is bottom position.

| Dip 1 | Dip 2 | Dip 3 | Dip 4 | Group address |
|--------------------------------------------------------------|-------|-------|-------|----------------------------------------------------------------------------------------------------------------------------------------------|
| 1: RS485 baud rate=9600 Restart to take effect. | 0 | 0 | 0 | Single group only. It's required to set up master battery with this setting and slave batteries are unrestricted. |
| | 1 | 0 | 0 | Multiple group condition. It's required to set up master battery on the first group with this setting and slave batteries are unrestricted. |
| | 0 | 1 | 0 | Multiple group condition. It's required to set up master battery on the second group with this setting and slave batteries are unrestricted. |
| | 1 | 1 | 0 | Multiple group condition. It's required to set up master battery on the third group with this setting and slave batteries are unrestricted. |
| | 0 | 0 | 1 | Multiple group condition. It's required to set up master battery on the fourth group with this setting and slave batteries are unrestricted. |
| | 1 | 0 | 1 | Multiple group condition. It's required to set up master battery on the fifth group with this setting and slave batteries are unrestricted. |

NOTE: The maximum groups of lithium battery is 5 and for maximum number for each group, please check with battery manufacturer.

3. Installation and Operation

After configuration, please install LCD panel with inverter and Lithium battery with the following steps.

Step 1. Use custom-made RJ45 cable to connect inverter and Lithium battery.

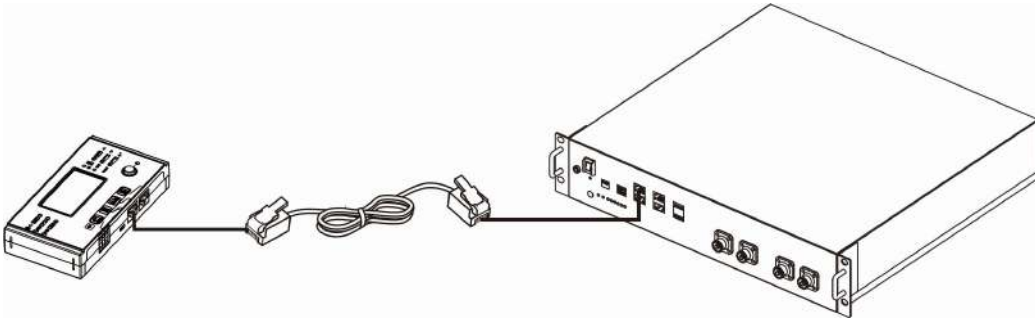

Please take notice for parallel system:

1. Only support common battery installation.
2. Use one custom-made RJ45 cable to connect any inverter (no need to connect to a specific inverter) and Lithium battery. Simply set battery type of this inverter to "PYL" in LCD program 5. The remaining inverters are set as "USE".

Step 2. Switch on Lithium battery.

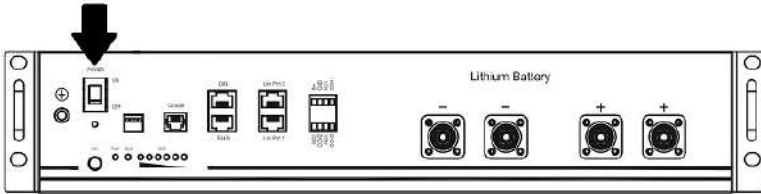

Step 3. Press more than three seconds to start Lithium battery. Output power is ready.

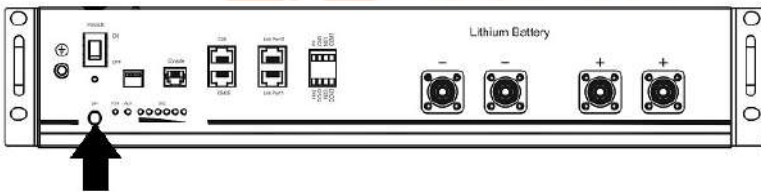

Step 4. Turn on the inverter.

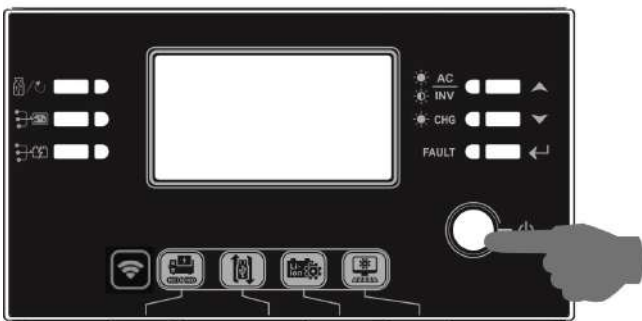

Step 5. Be sure to select battery type as "PYL" in LCD program 5.

05 

PYL

If communication between the inverter and battery is successful, the battery icon  on LCD display will flash. Generally speaking, it will take longer than 1 minute to establish communication.

WECO

Step 1. Use a custom-made RJ45 cable to connect inverter and Lithium battery.

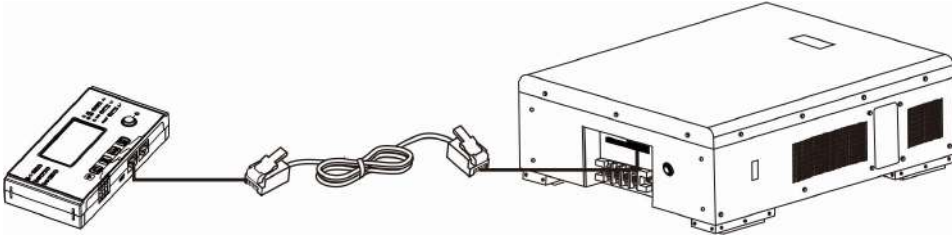

Please take notice for parallel system:

3. Only support common battery installation.
4. Use one custom-made RJ45 cable to connect any inverter (no need to connect to a specific inverter) and Lithium battery. Simply set battery type of this inverter to "WEC" in LCD program 5. The remaining inverters are set as "USE".

Step 2. Switch on Lithium battery.

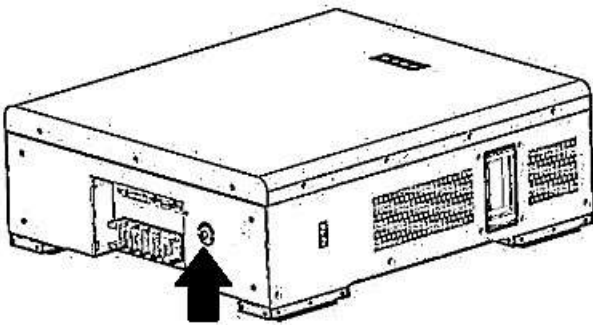

Step 3. Turn on the inverter.

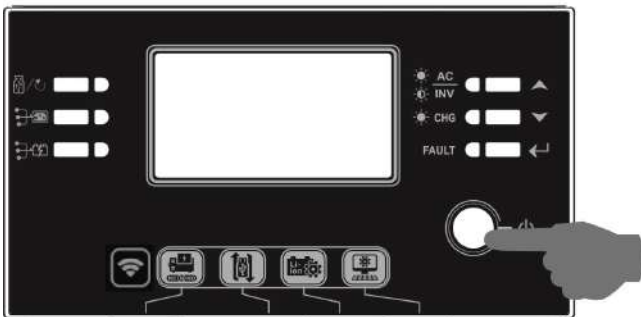

Step 4. Be sure to select battery type as "WEC" in LCD program 5.

05 

WEC

If communication between the inverter and battery is successful, the battery icon  on LCD display will "flash". Generally speaking, it will take longer than 1 minute to establish communication.

SOLTARO

Step 1. Use a custom-made RJ45 cable to connect inverter and Lithium battery.

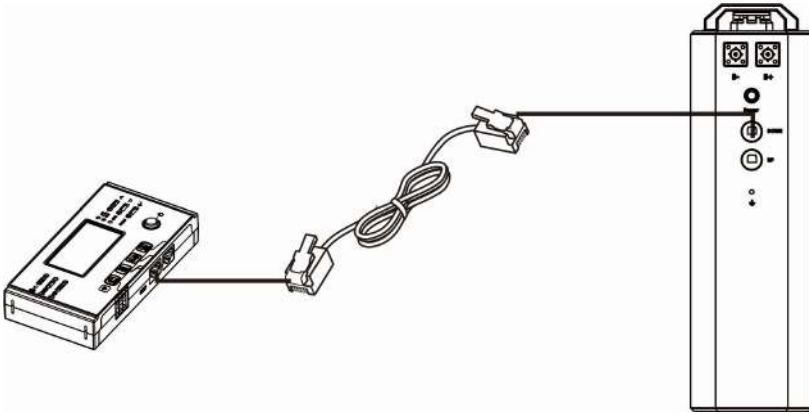

Please take notice for parallel system:

1. Only support common battery installation.
2. Use one custom-made RJ45 cable to connect any inverter (no need to connect to a specific inverter) and Lithium battery. Simply set battery type of this inverter to "SOL" in LCD program 5. The remaining inverters are set as "USE".

Step 2. Open DC isolator and switch on Lithium battery.

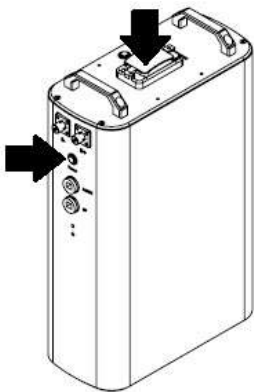

Step 3. Turn on the inverter.

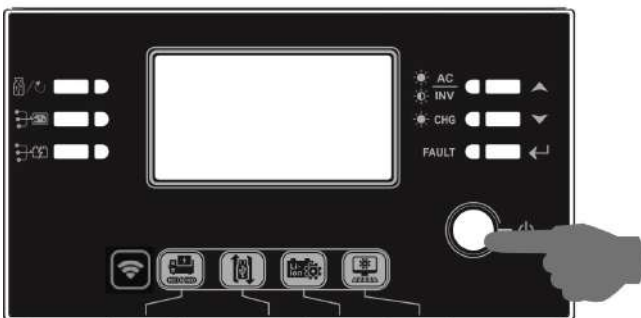

Step 4. Be sure to select battery type as "SOL" in LCD program 5.

05 

SOL

If communication between the inverter and battery is successful, the battery icon  on LCD display will "flash". Generally speaking, it will take longer than 1 minute to establish communication.



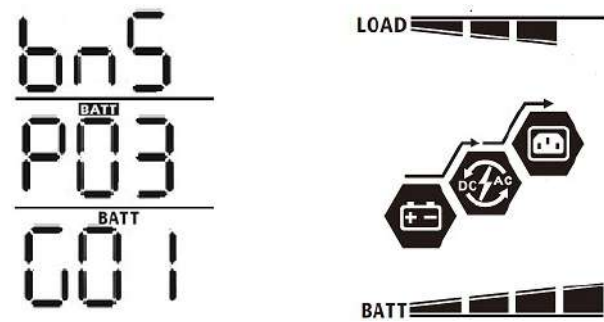

4. LCD Display Information

Press "UP" or "DOWN" key to switch LCD display information. It will show battery pack and battery group number before "Main CPU version checking" as below screen.

| Selectable information | LCD display |
|----------------------------------------------|-----------------------------------------------------------------------------------------------------------------------------------------------|
| Battery pack numbers & Battery group numbers | <p>Battery pack numbers = 3, battery group numbers = 1</p>  |

5. Code Reference

Related information code will be displayed on LCD screen. Please check inverter LCD screen for the operation.

| Code | Description | Action |
|----------------------------------------------------------------------------------------|-----------------------------------------------------------------------------------------------------------------------------------------------------------------------------------------------------------------------------------------------------------------------------------------------------------------------------------------------------------------------------------------------------------------------------------------------------------|--------|
| 60  | If battery status is not allowed to charge and discharge after the communication between the inverter and battery is successful, it will show code 60 to stop charging and discharging battery. | |
| 61  | Communication lost (only available when the battery type is setting as "Pylontech Battery"). <ul style="list-style-type: none"> After battery is connected, communication signal is not detected for 3 minutes, buzzer will beep. After 10 minutes, inverter will stop charging and discharging to lithium battery. Communication lost occurs after the inverter and battery is connected successfully, buzzer beeps immediately. | |
| 69  | If battery status is not allowed to charge after the communication between the inverter and battery is successful, it will show code 69 to stop charging battery. | |
| 70  | If battery status must to charge after the communication between the inverter and battery is successful, it will show code 70 to charge battery. | |
| 71  | If battery status is not allowed to discharge after the communication between the inverter and battery is successful, it will show code 71 to stop discharging battery. | |

Appendix C: The Wi-Fi Operation Guide in Remote Panel

1. Introduction

Wi-Fi module can enable wireless communication between off-grid inverters and monitoring platform. Users have complete and remote monitoring and controlling experience for inverters when combining Wi-Fi module with WatchPower APP, available for both iOS and Android based device. All data loggers and parameters are saved in iCloud.

The major functions of this APP:

- Delivers device status during normal operation.
- Allows to configure device setting after installation.
- Notifies users when a warning or alarm occurs.
- Allows users to query inverter history data.



2. WatchPower App

2-1. Download and install APP

Operating system requirement for your smart phone:

🍏 iOS system supports iOS 9.0 and above

🤖 Android system supports Android 5.0 and above

Please scan the following QR code with your smart phone and download WatchPower App.



Android
system





iOS system

Or you may find "WatchPower" app from the Apple® Store or "WatchPower Wi-Fi" in Google® Play Store.



2-2. Initial Setup

Step 1: Registration at first time

After the installation, please tap the shortcut icon  to access this APP on your mobile screen. In the screen, tap "Register" to access "User Registration" page. Fill in all required information and scan the remote box PN by tapping  icon. Or you can simply enter PN directly. Then, tap "Register" button.



Then, a "Registration success" window will pop up. Tap "Go now" to continue setting local Wi-Fi network connection.



Step 2: Local Wi-Fi Module Configuration

Now, you are in "Wi-Fi Config" page. There are detailed setup procedure listed in "How to connect?" section and you may follow it to connect Wi-Fi.

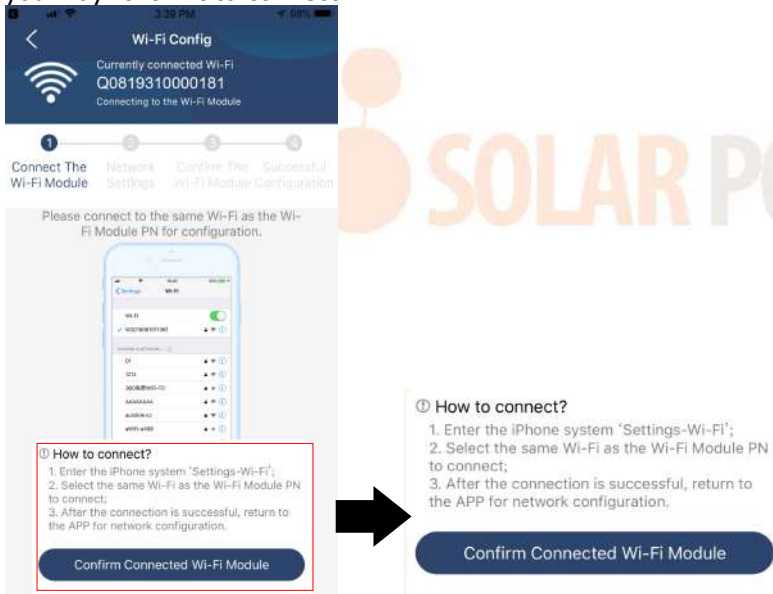

Enter the "Settings→Wi-Fi" and select connected Wi-Fi name. The connected Wi-Fi name is the same to your Wi-Fi PN number and enter default password "12345678".

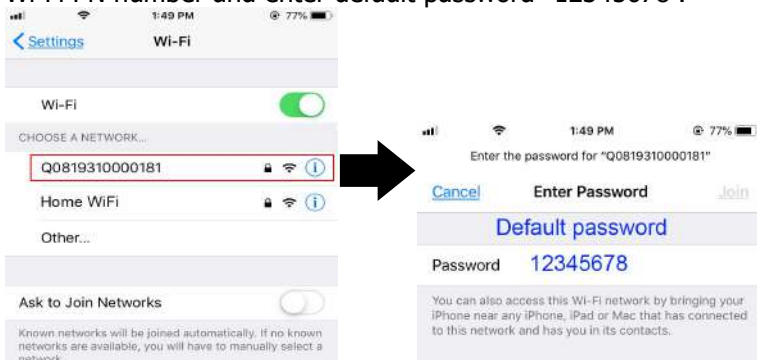

Then, return to WatchPower APP and tap “ **Confirm Connected Wi-Fi Module** ” button when Wi-Fi module is connected successfully.

Step 3: Wi-Fi Network settings

Tap  icon to select your local Wi-Fi router name (to access the internet) and enter password.

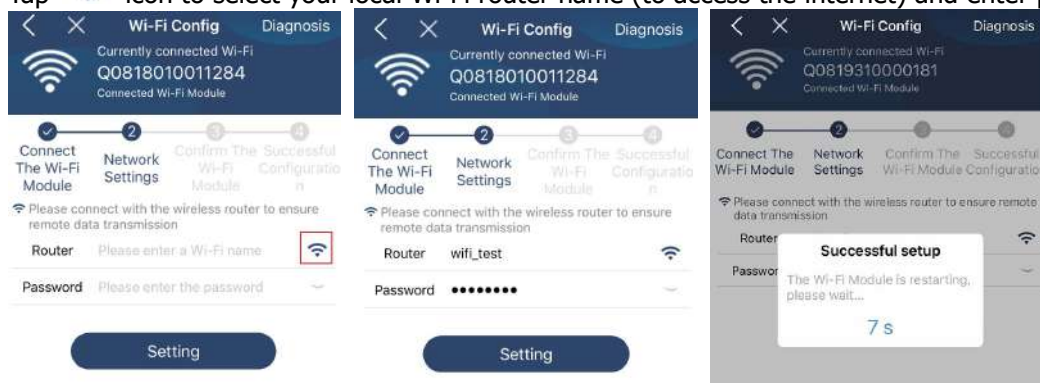

Step 4: Tap “Confirm” to complete the Wi-Fi configuration between the Wi-Fi module and the Internet.



If the connection fails, please repeat Step 2 and 3.

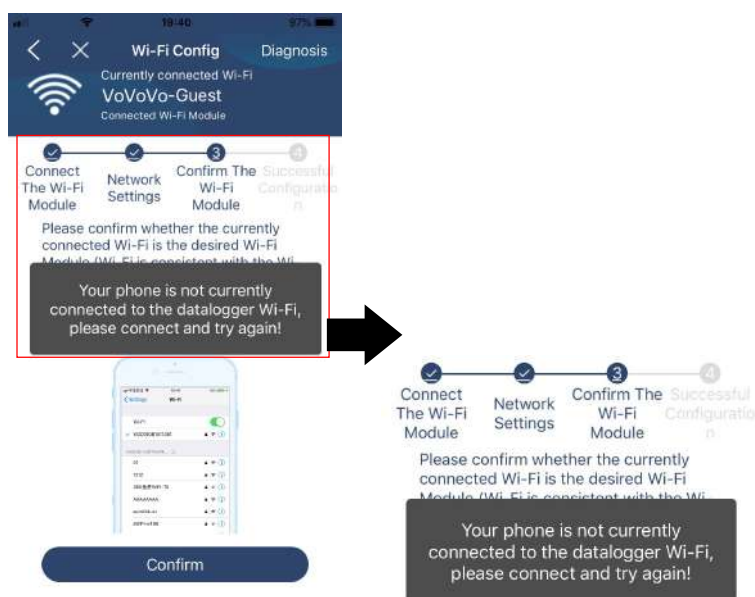

Diagnose Function

If the module is not monitoring properly, please tap “ **Diagnosis** ” on the top right corner of the screen for further details. It will show repair suggestion. Please follow it to fix the problem. Then, repeat the steps in the chapter 4.2 to re-set network setting. After all setting, tap “Rediagnosis” to re-connect again.

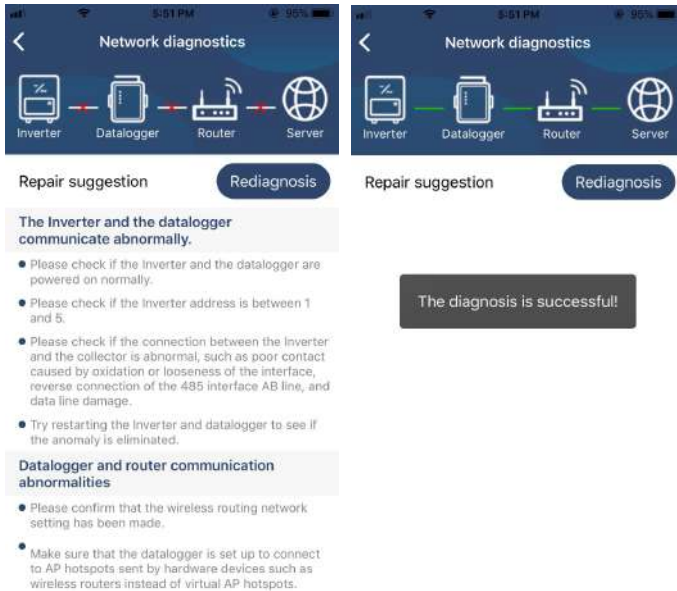

2-3.Login and APP Main Function

After finishing the registration and local Wi-Fi configuration, enter registered name and password to login.
 Note: Tick "Remember Me" for your login convenience afterwards.

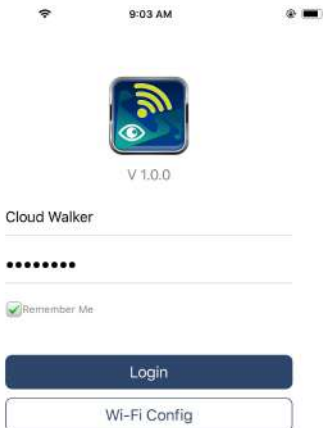

Overview

After login is successfully, you can access "Overview" page to have overview of your monitoring devices, including overall operation situation and Energy information for Current power and Today power as below diagram.



Devices

Tap the  icon (located on the bottom) to enter Device List page. You can review all devices here by adding or deleting Wi-Fi Module in this page.

Add device

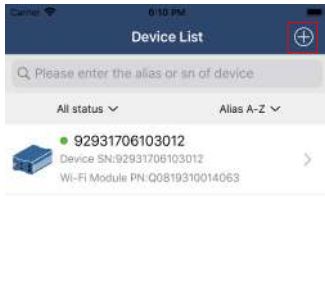

Delete device

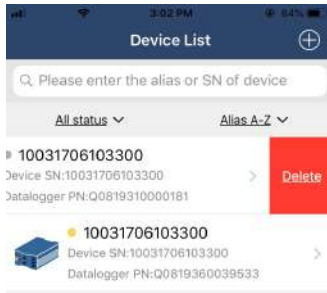

Tap  icon on the top right corner and manually enter part number to add device. This part number label is pasted on the bottom of remote LCD panel. After entering part number, tap "Confirm" to add this device in the Device list.

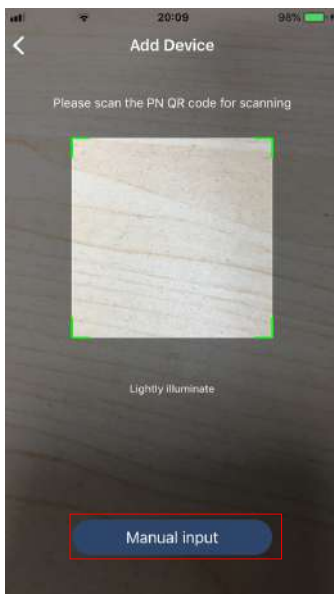

Part number label is pasted on the bottom of remote LCD panel.



For more information about Device List, please refer to the section 2.4.

ME

In ME page, users can modify "My information", including **【User's Photo】**, **【Account security】**, **【Modify password】**, **【Clear cache】**, and **【Log-out】**, shown as below diagrams.

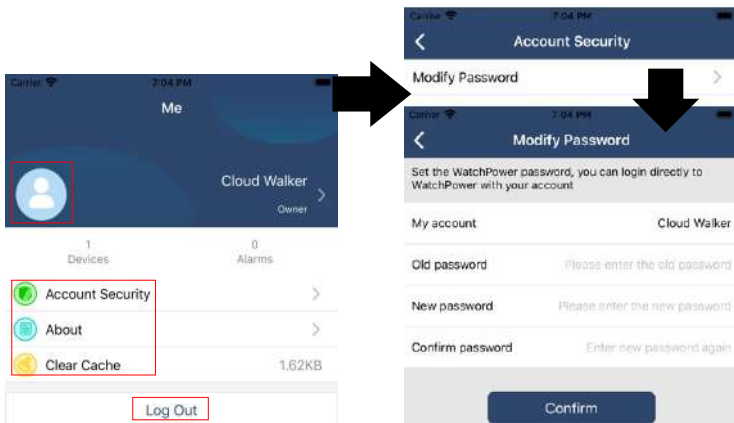

2-4. Device List

In Device List page, you can pull down to refresh the device information and then tap any device you want to check up for its real-time status and related information as well as to change parameter settings. Please refer to the parameter setting list.

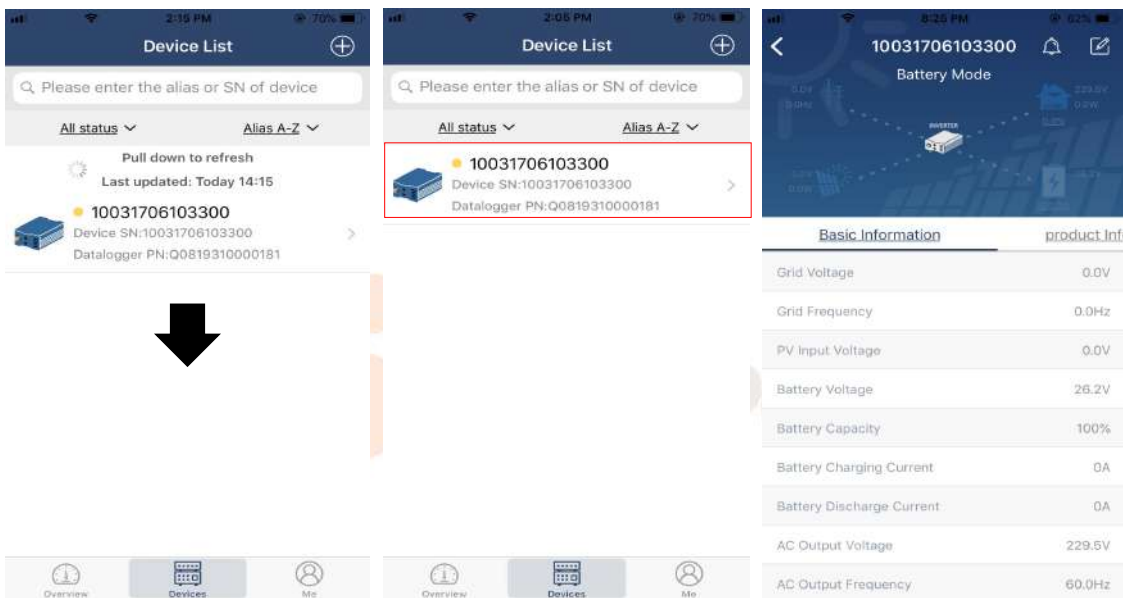

Device Mode

On the top of screen, there is a dynamic power flow chart to show live operation. It contains five icons to present PV power, inverter, load, utility and battery. Based on your inverter model status, there will be **【Standby Mode】** , **【Line Mode】** , **【Battery Mode】** .

【Standby Mode】 Inverter will not power the load until “ON” switch is pressed. Qualified utility or PV source can charge battery in standby mode.

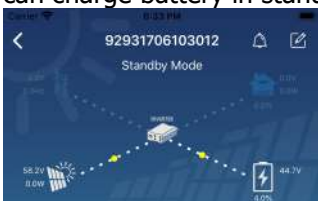

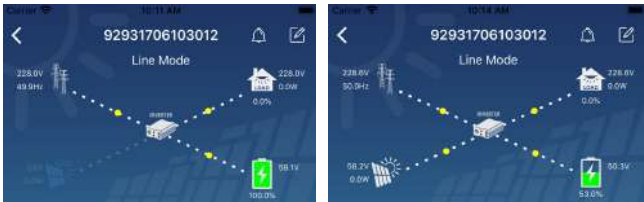

【Line Mode】 Inverter will power the load from the utility with or without PV charging. Qualified utility or PV source can charge battery.



【Battery Mode】 Inverter will power the load from the batter with or without PV charging. Only PV source can charge battery.



Device Alarm and Name Modification

In this page, tap the  icon on the top right corner to enter the device alarm page. Then, you can review alarm history and detailed information. Tap the  icon on the top right corner, a blank input box will pop out. Then, you can edit the name for your device and tap "Confirm" to complete name modification.

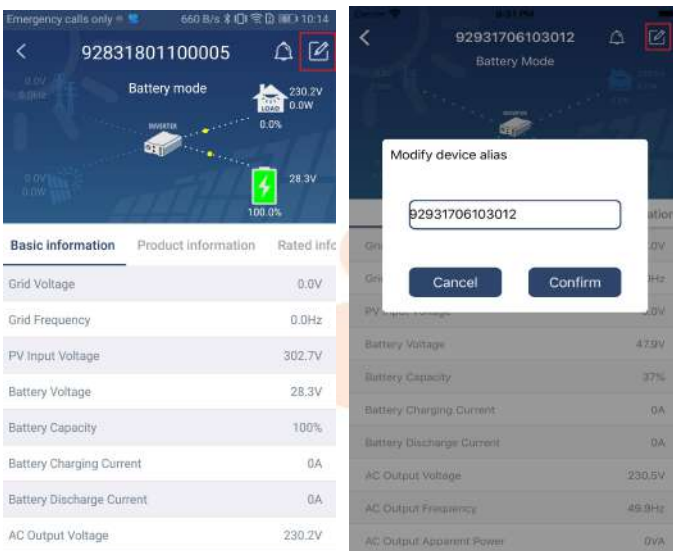

Device Information Data

Users can check up **【Basic Information】**, **【Product Information】**, **【Rated information】**, **【History】**, and **【Wi-Fi Module Information】** by swiping left.

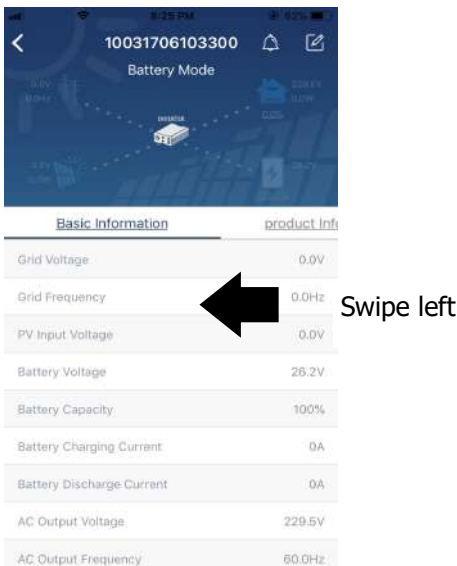

【Basic Information】 displays basic information of the inverter, including AC voltage, AC frequency, PV input voltage, Battery voltage, Battery capacity, Charging current, Output voltage, Output frequency, Output apparent power, Output active power and Load percent. Please slide up to see more basic information.

【Production Information】 displays Model type (Inverter type), Main CPU version, Wi-Fi CPU version and secondary CPU version.

【Rated Information】 displays information of Nominal AC voltage, Nominal AC current, Rated battery voltage, Nominal output voltage, Nominal output frequency, Nominal output current, Nominal output apparent power and Nominal output active power. Please slide up to see more rated information.

【History】 displays the record of unit information and setting timely.

【Wi-Fi Module Information】 displays of Wi-Fi Module PN, status and firmware version.

Parameter Setting

This page is to activate some features and set up parameters for inverters. Please be noted that the listing in "Parameter Setting" page in below diagram may differ from the models of monitored inverter. Here will briefly highlight some of it, **【Output Setting】**, **【Battery Parameter Setting】**, **【Enable/ Disable items】**, **【Restore to the defaults】** to illustrate.



There are three ways to modify setting and they vary according to each parameter.

- a) Listing options to change values by tapping one of it.
- b) Activate/Shut down functions by clicking "Enable" or "Disable" button.
- c) Changing values by clicking arrows or entering the numbers directly in the column.

Each function setting is saved by clicking "Set" button.

Please refer to below parameter setting list for an overall description and be noted that the available parameters may vary depending on different models. Please always see the original product manual for detailed setting instructions.

Parameter setting list:

| Item | Description | |
|---------------------------|--------------------------|-------------------------------------------------------------------------------------------------------------------|
| Output setting | Output source priority | To configure load power source priority. |
| | AC input range | When selecting "UPS", it's allowed to connect personal computer. Please check product manual for details. |
| | | When selecting "Appliance", it's allowed to connect home appliances. |
| | Output voltage | To set output voltage. |
| Output frequency | To set output frequency. | |
| Battery parameter setting | Battery type: | To set connected battery type. |
| | Battery cut-off voltage | To set the battery stop discharging voltage. Please see product manual for the recommended voltage range based |

| | | |
|--------------------------|-----------------------------------------|---------------------------------------------------------------------------------------------------------------------------------------------------------------------------------------|
| | | on connected battery type. |
| | Back to grid voltage | When "SBU" or "SOL" is set as output source priority and battery voltage is lower than this setting voltage, unit will transfer to line mode and the grid will provide power to load. |
| | Back to discharge voltage | When "SBU" or "SOL" is set as output source priority and battery voltage is higher than this setting voltage, battery will be allowed to discharge. |
| | Charger source priority: | To configure charger source priority. |
| | Max. charging current | It's to set up battery charging parameters. The selectable values in different inverter model may vary. Please see product manual for the details. |
| | Max. AC charging current: | |
| | Float charging voltage | |
| | Bulk charging voltage | It's to set up battery charging parameters. The selectable values in different inverter model may vary. Please see product manual for the details. |
| | Battery equalization | Enable or disable battery equalization function. |
| | Real-time Activate Battery Equalization | It's real-time action to activate battery equalization. |
| | Equalized Time Out | To set up the duration time for battery equalization. |
| | Equalized Time | To set up the extended time to continue battery equalization. |
| | Equalization Period | To set up the frequency for battery equalization. |
| | Equalization Voltage | To set up the battery equalization voltage. |
| Enable/Disable Functions | LCD Auto-return to Main screen | If enable, LCD screen will return to its main screen after one minute automatically. |
| | Fault Code Record | If enabled, fault code will be recorded in the inverter when any fault happens. |
| | Backlight | If disabled, LCD backlight will be off when panel button is not operated for 1 minute. |
| | Bypass Function | If enabled, unit will transfer to line mode when overload happened in battery mode. |
| | Beeps while primary source interrupt | If enabled, buzzer will alarm when primary source is abnormal. |
| | Over Temperature Auto Restart | If disabled, the unit won't be restarted after over-temperature fault is solved. |
| | Overload Auto Restart | If disabled, the unit won't be restarted after overload occurs. |
| | Buzzer | If disabled, buzzer won't be on when alarm/fault occurred. |
| RGB LED Setting | Enable/disable | Turn on or off RGB LEDs |

| | | |
|------------------------|--------------------------------------------------------------------|------------------------------------------------------------------|
| | Brightness | Adjust the lighting brightness |
| | Speed | Adjust the lighting speed |
| | Effects | Change the light effects |
| | Color selection | Adjust color combination to show energy source an battery status |
| Restore to the default | This function is to restore all settings back to default settings. | |

